

# Yealink

## DECT IP Phone W53P & W53H

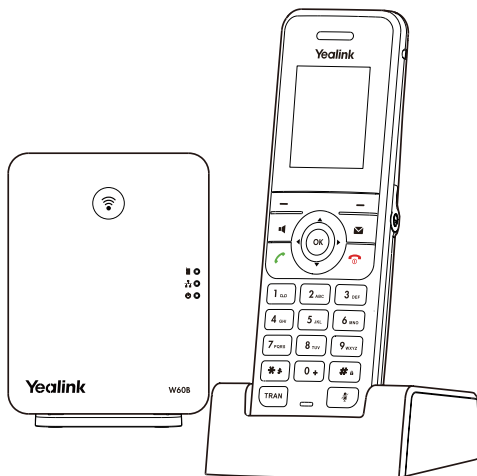

### Quick Start Guide(V83.13)

For W60B firmware: 77.83.0.10 or later  
For W53H firmware: 88.83.0.10 or later

# W53P Package Contents



W53H Handset



Battery Cover



W60B Base Station



Base Stand



Charger Cradle



2 Power Adapters



Ethernet Cable



Belt Clip



Rechargeable Battery



Quick Start Guide

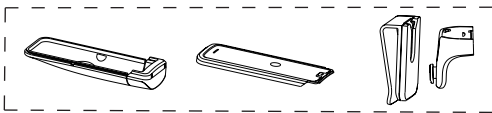

Handset Protective Case (Optional)

Note: Yealink W53P DECT IP phone consists of one W60B base station and one W53H handset.

# W53H Package Contents



W53H Handset



Battery Cover



Charger Cradle



Power Adapter



Belt Clip



Rechargeable Battery

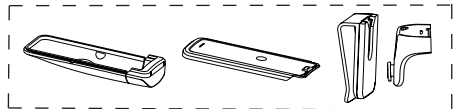

Handset Protective Case (Optional)

Note: We recommend that you use the accessories provided or approved by Yealink.  
The use of unapproved third-party accessories may result in reduced performance.

# W60B Package Contents



W60B Base Station

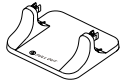

Base Stand



Power Adapter



Ethernet Cable



Quick Start Guide

## Assembling the DECT Phone

### 1. Connect the base station power and the network using method a or method b.

#### a. AC Power Option

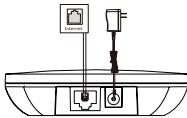

#### b. PoE (Power Over Ethernet) Option

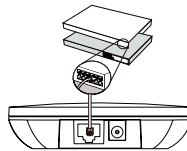

#### Note:

- If you choose method a, use Yealink-supplied power adapter (5V/600mA). A third-party power adapter may damage the base station.
- If you choose method b, you do not need to connect the power adapter. Make sure the hub/switch is PoE-compliant.

### 2a. (Desktop Installation) Attach and remove the base stand.

#### Attach the Base Stand

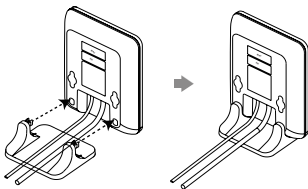

Align the snap-fits with the corresponding holes and push forward, snapping them into the holes.

#### Remove the Base Stand

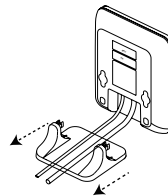

Remove the snap-fits from the holes horizontally.

**2b. (Wall-Mount Installation) Attach the base station.**

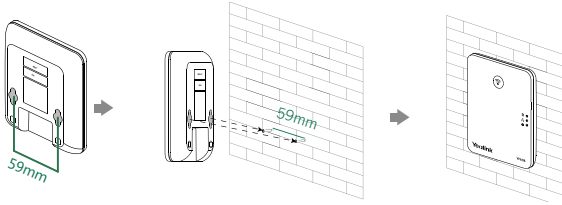

**3. Insert the battery into the handset.**



**4. Attach the belt clip to the handset.**

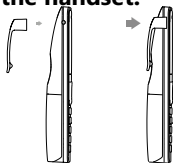

**5. (Optional) Put the handset in the protective case and attach the belt clip.**

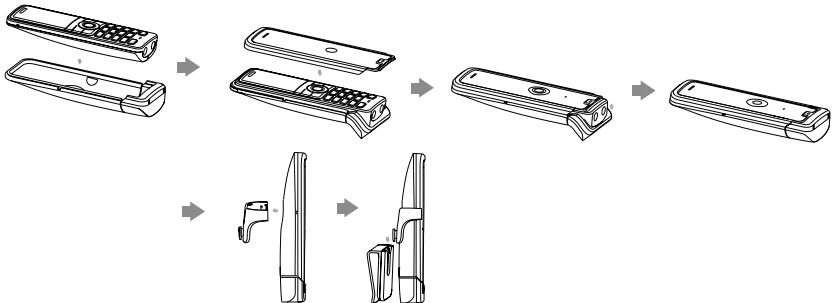

**6. (Optional) Mount the charger cradle to the wall.**

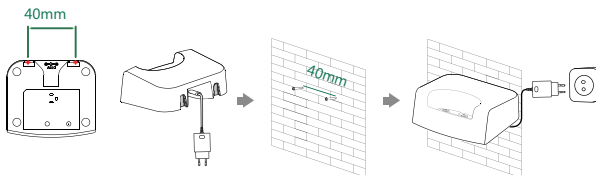

## 7. Connect the charger cradle and charge the handset.

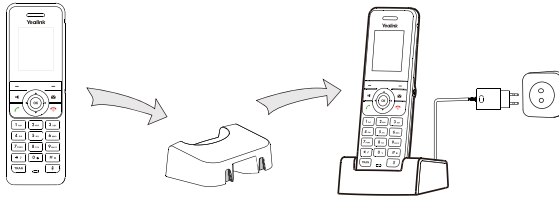

### Note:

- Use Yealink-supplied power adapter (5V/600mA). A third-party power adapter may damage the handset.
- Check the charging status on the top-right corner of the LCD screen.

# Getting Started

## Shortcut Keys

Shortcut keys help you quickly access the frequently used phone features. The following describes the default shortcut-keys behaviors:



- ① Access the call history records.
- ② Check the line status.
- ③ Access the intercom list, select one to place an internal call.
- ④ Decrease the ringer volume.
- ⑤ Increase the ringer volume.
- ⑥ Access the directory list.

## Entering and Editing Data

- Press **#** one or more times to switch among different input modes or to type “##”.
- Press **\*** to provide the special characters to choose or to type “\*”.
- Press a digit key one or more times to type the desired character or digit.
- Press the **Del** soft key to delete entered characters.
- Press the **Save** soft key to accept the change or the **Back** soft key to cancel.

## Handset Registration

You can register up to 8 handsets to one W60B base station. Each handset can be registered to 4 different base stations.

When the handset LCD screen prompts "Unregistered!", long press  on the base station till the registration LED indicator flashes.

There are two methods to register a new handset:

### Easy Registration:

1. Press the **Reg** soft key on the handset to register quickly.

### Normal Registration:

1. Press the **OK** soft key on the handset, and then select **Register Handset**.
2. Select the desired base station and then press the **OK** soft key. The handset begins searching the base station.
3. Press the **OK** soft key after searching a base station successfully.
4. Enter the base station PIN (default: 0000), and then press the **Done** soft key to complete the registration.

To register to multiple base stations, press **OK** to enter the main menu, and select **Settings->Registration->Register Handset**, then repeat steps 2-4.

Note:

- If the handset is registered to the base station successfully, the handset LCD screen prompts "Handset Subscribed" and "Base NO." (the last 4 characters indicate the base station's MAC address).
- If the handset LCD screen prompts "Searching for Base", check that your base station is powered on.

## Network Settings

You can configure the base station to obtain network settings in one of the following ways:

### DHCP

By default, the base station attempts to contact a DHCP server in your network to obtain the valid network settings, such as IP address, subnet mask, gateway address and DNS address.

### Static

If the base station cannot contact a DHCP server for any reason, you need to configure the IP address, subnet mask, gateway address, primary DNS address and secondary DNS address for the base station manually.

**To configure the network parameters for the base station manually:**

1. Press the **OK** key to enter the main menu, and then select **Settings->System Settings -> Network** (default PIN: 0000)->**Basic**.
2. Select the desired IP addressing mode from the **IP Mode** field.
3. Press **▼** to select the desired IP addressing mode.

4. Make the desired changes.
5. Press the **Save** soft key to accept the change.

**Note:**

- The DECT IP phone supports either or both IPv4 and IPv6 addressing modes, but IPv6 is disabled by default.
- Wrong network settings may result in inaccessibility of your phone and may affect the network performance. Contact your system administrator for the network parameters.

## Basic Operations

### Turning Handset On/Off



**To turn the handset on, do one of the following:**

- Press , wait until the LCD screen lights up.
- Place the handset in the charger cradle. The handset will be turned on automatically.



**To turn the handset off:**

Long press  to turn the handset off.

### Locking/Unlocking Keypad

- Long press  when the handset is idle to lock the keypad.
- Long press  again to unlock the keypad.

### Silent Mode

- Long press  when the handset is idle to switch the silent mode to on.
- Long press  again to switch the silent mode to off.





## Handset Settings

### Handset Name

**To rename the handset:**

1. Press the **OK** key to enter the main menu, and then select **Settings->Handset Name**.
2. Edit the value in the **Rename** field.
3. Press the **Save** soft key to accept the change.

### Volume Adjustment

- Press  or  when the handset is idle or ringing to adjust the ringer volume.
- Press  or  during a call to adjust the receiver volume of speakerphone/earpiece/headset.

### Ring Tones

1. Press the **OK** key to enter the main menu, and then select **Settings->Audio->Ring Tones->Melodies**.
2. Press **▲** or **▼** to highlight **Intercom Call** or the desired line.
3. Press **◀** or **▶** to select the desired ring tone.
4. Press the **Save** soft key to accept the change.

## Local Directory

### To add a contact:

1. Press the **OK** key to enter the main menu, and then select **Directory**.
2. Press the **Options** soft key, and then select **New Contact**.
3. Enter the desired value in the **Name**, **Office**, **Mobile** and **Other** field respectively.
4. Press the **Save** soft key to accept the change.

### To edit a contact:

1. Press the **OK** key to enter the main menu, and then select **Directory**.
2. Press **▲** or **▼** to highlight the desired entry.
3. Press the **Options** soft key, and then select **Edit**.
4. Edit the desired value in the **Name**, **Office**, **Mobile** and **Other** field respectively.
5. Press the **Save** soft key to accept the change.

### To delete a contact:

1. Press the **OK** key to enter the main menu, and then select **Directory**.
2. Press **▲** or **▼** to highlight the desired entry.
3. Press the **Options** soft key, and then select **Delete** to delete the selected entry.
4. Press the **Yes** soft key when the LCD screen prompts "Do you want to delete the selected item?".

## Speed Dial

1. Press the **OK** key to enter the main menu, and then select **Settings->Telephony->Speed Dial**.
2. Press **▲** or **▼** to highlight the desired digit key, and then press the **Assign** soft key.
3. Press **▲** or **▼** to select the desired directory type.
4. Press **▲** or **▼** to highlight the desired entry, and then press the **OK** soft key.  
If both the office number and mobile number are stored, press **▲** or **▼** to highlight the desired number, and then press the **OK** soft key again.

# Basic Call Features



## Placing Calls

### To place a call directly:









1. Do one of the following:







- Enter the desired number when the handset is idle.
- Press  to enter the pre-dialing screen. Enter the desired number using the keypad. If there are multiple lines assigned to your handset as outgoing lines, press the **Line** soft key to select the desired line. If you do not select a line, the handset uses the default outgoing line to dial out.

2. Press ,  or  to dial out.





#### **To place a call from the local directory:**

1. Press  when the handset is idle.
2. Press  or  to select the desired directory type.
3. Highlight the desired entry, and then press  or  to dial out using the default line. If multiple numbers for the contact are stored, press  or  to highlight the desired number, and then press  or  again to dial out using the default line.

#### **To place a call from the call history:**

1. Press the **History** soft key when the handset is idle, and then select the desired call history list.
2. Press  or  to highlight the desired entry, and then press  or  to dial out using the default line.

#### **To place a call from the redial list:**



1. Press  when the handset is idle.
2. Press  or  to highlight the desired entry, and then press  or .

#### **To place a call using the speed dial key:**

Long press the speed dial key to call the preset number directly.

## **Answering Calls**

#### **To answer a call, do one of the following:**



- Press the **Accept** soft key.
- Press .
- Press .
- Press .

Note: You can ignore an incoming call by pressing the **Silence** soft key or reject an incoming call by pressing .

## **Ending Calls**

Press .

### **Call Mute**

- Press  during a call to mute the call.
- Press  again to un-mute the call.

### **Call Hold and Resume**

**To place a call on hold:**

Press the **Options** soft key during a call, and then select **Hold**.

**To resume a call, do one of the following:**

- If there is only a call on hold, press the **Resume** soft key.
- If there are two calls on hold, press the **Resume** soft key to resume the current call.  
Press the **Swap** soft key to swap between calls.



## Call Transfer

You can transfer a call in one of the following ways:



### Blind Transfer

1. Press the **Options** soft key during a call, and then select **Transfer**.
2. Enter the number you want to transfer the call to.
3. Press the **Transfer** soft key.

### Semi-Attended Transfer

1. Press the **Options** soft key during a call, and then select **Transfer**.
2. Enter the number you want to transfer the call to.
3. Press ,  or  to dial out.
4. Press the **Transfer** soft key when you hear the ring-back tone.

### Attended Transfer

1. Press the **Options** soft key during a call, and then select **Transfer**.
2. Enter the number you want to transfer the call to.
3. Press ,  or  to dial out.
4. Press the **Transfer** soft key after the call is answered.

## Call Forward

**To enable the call forward feature on a specific line:**

1. Press the **OK** key to enter the main menu, and then select **Call Features->Call Forward**.
2. If there are multiple lines assigned to your handset, press **▲** or **▼** to highlight the desired line, and then press the **OK** soft key.
3. Press **▲** or **▼** to highlight the desired forwarding type, and then press the **OK** soft key.
  - **Always**---Incoming calls are forwarded immediately.
  - **Busy**---Incoming calls are forwarded when the line is busy.
  - **No Answer**---Incoming calls are forwarded if not answered after a period of time.
4. Select **Enabled** from the **Status** field.
5. Enter the number you want to forward the incoming calls to in the **Target** field.  
For **No Answer Forward**, press **◀** or **▶** to select the desired ring time to wait before forwarding in the **After Ring Time** field.

## Regulatory Notices

### Operating Ambient Temperatures

- Operating temperature: +32 to 104°F (0 to 40°C)
- Relative humidity: 5% to 90%, noncondensing
- Storage temperature: -22 to +160°F (-30 to +70°C)

### Warranty

Our product warranty is limited only to the unit itself, when used normally in accordance with the operating instructions and the system environment. We are not liable for damage or loss resulting from the use of this product, or for any claim from a third party. We are not liable for problems with Yealink device arising from the use of this product; we are not liable for financial damages, lost profits, claims from third parties, etc., arising from the use of this product.

### Explanation of the symbols

- DC symbol
- ≡ is the DC voltage symbol.
- WEEE Warning symbol

 To avoid the potential effects on the environment and human health as a result of the presence of hazardous substances in electrical and electronic equipment, end users of electrical and electronic equipment should understand the meaning of the crossed-out wheeled bin symbol. Do not dispose of WEEE as unsorted municipal waste and have to collect such WEEE separately.

### Restriction of Hazardous Substances Directive (RoHS)

This device complies with the requirements of the EU RoHS Directive. Statements of compliance can be obtained by contacting support@yealink.com.

### Safety Instructions

Save these instructions. Read these safety instructions before use!

#### General Requirements

- Before you install and use the device, read the safety instructions carefully and observe the situation during operation.
- During the process of storage, transportation, and operation, please always keep the device dry and clean, avoid collision and crash.
- Please attempt not to dismantle the device by yourself. In case of any discrepancy, please contact the appointed maintenance center for repair.
- Please refer to the relevant laws and statutes while using the device. Legal rights of others should be respected as well.

#### Environmental Requirements

- Place the device at a well-ventilated place. Do not expose the device under direct sunlight.
- Keep the device dry and free of dusts.
- Do not place the device on or near any inflammable or fire-vulnerable object, such as rubber-made materials.
- Keep the device away from any heat source or bare fire, such as a candle or an electric heater.

#### Operating Requirements

- Do not let a child operate the device without guidance.
- Do not let a child play with the device or any accessory in case of accidental swallowing.
- Please use the accessories provided or authorized by the manufacturer only.
- The power supply of the device shall meet the requirements of the input voltage of the device. Please use the provided surge protection power socket only.
- Before plugging or unplugging any cable, make sure that your hands are completely dry.
- Do not spill liquid of any kind on the product or use the equipment near water, for example, near a bathtub, washbowl, kitchen sink, wet basement or near a swimming pool.
- During a thunderstorm, stop using the device and disconnect it from the power supply. Unplug the power plug and the Asymmetric Digital Subscriber Line (ADSL) twisted pair (the radio frequency cable) to avoid lightning strike.
- If the device is left unused for a rather long time, disconnect it from the power supply and unplug the power plug.
- When there is smoke emitted from the device, or some abnormal noise or smell, disconnect the device from the power supply, and unplug the power plug immediately.
- Contact the specified maintenance center for repair.
- Do not insert any object into equipment slots that is not part of the product or auxiliary product.
- Before connecting a cable, connect the grounding cable of the device first.
- Do not disconnect the grounding cable until you disconnect all other cables

#### Battery Requirements

- Do not immerse the battery into water, which could short-circuit and damage the battery.

- Do not expose the battery to an open flame or leave the battery where it could be subjected to extremely high temperatures, which could cause the battery to explode.
- Do power the handset off before removing the battery.
- Do not try to use the battery for the power supply of any device other than this handset.
- Do not open or mutilate the battery, released electrolyte is corrosive and may cause damage to your eyes or skin.
- Use only the rechargeable battery pack delivered with the handset or those rechargeable battery packs expressly recommended by Yealink.
- Defective or exhausted battery should never be disposed of as municipal waste. Return old battery to the battery supplier, a licensed battery dealer or a designated collection facility.

#### Cleaning Requirements

- Before cleaning the device, disconnect it from the power supply.
- Use a piece of soft, dry and anti-static cloth to clean the device.
- Keep the power plug clean and dry.

#### Troubleshooting

The unit cannot supply power to Yealink device.

There is a bad connection with the plug.

1. Clean the plug with a dry cloth.
2. Connect it to another wall outlet.

The usage environment is out of operating temperature range.

1. Use in the operating temperature range.

The cable between the unit and the Yealink device is connected incorrectly.

1. Connect the cable correctly.

You cannot connect the cable properly.

1. You may have connected a wrong Yealink device.
2. Use the correct power supply.

Some dust, etc., may be in the port.

1. Clean the port.

Contact your dealer or authorized service facility for any further questions.

#### FCC Statement

This device complies with part 15 of the FCC Rules. Operation is subject to the following two conditions: (1) this device may not cause harmful interference, and (2) this device must accept any interference received, including interference that may cause undesired operation.

Any Changes or modifications not expressly approved by the party responsible for compliance could void the user's authority to operate the equipment.

#### IC Statement

This device complies with Industry Canada's licence-exempt RSSs. Operation is subject to the following two conditions:

(1) this device may not cause interference; and

(2) this device must accept any interference, including interference that may cause undesired operation of the device. CAN ICES-3(B)

Le présent appareil est conforme aux CNR de l'Industrie Canada applicables aux appareils radio exempts de licence. L'exploitation est autorisée aux deux conditions suivantes :

(1) l'appareil ne doit pas produire de brouillage;

(2) l'utilisateur de l'appareil doit accepter tout brouillage radioélectrique subi, même si le brouillage est susceptible d'en compromettre le fonctionnement. NMB-3(B)

#### Radiation Exposure Statement

This equipment complies with FCC and IC radiation exposure limits set forth for an uncontrolled environment. This equipment should be installed and operated with minimum distance 20cm between the radiator and your body.

Cet émetteur ne doit pas être Co-placé ou ne fonctionnant en même temps qu'aucune autre antenne ou émetteur. Cet équipement devrait être installé et opérationnel avec une distance minimum de 20 centimètres entre le radiateur et votre corps.

#### Contact Information

YEALINK NETWORK TECHNOLOGY CO., LTD.

309, 3rd Floor, No.16, Yun Ding North Road, Huli District, Xiamen City, Fujian, P.R. China

YEALINK (EUROPE) NETWORK TECHNOLOGY B.V.

Strawinskylaan 3127, Atrium Building, 8th floor, 1077ZX Amsterdam, The Netherlands

YEALINK (USA) NETWORK TECHNOLOGY CO., LTD.

999 Peachtree Street Suite 2300, Fulton, Atlanta, GA, 30309, USA

Made in China

## About Yealink

Yealink is a global leading provider of enterprise communication and collaboration solutions, offering video conferencing service to worldwide enterprises. Focusing on research and development, Yealink also insists on innovation and creation. With the outstanding technical patents of cloud computing , audio, video and image processing technology, Yealink has built up a panoramic collaboration solution of audio and video conferencing by merging its cloud services with a series of endpoints products. As one of the best providers in more than 140 countries and regions including the US, the UK and Australia, Yealink ranks No.1 in the global market share of SIP phones shipments.

## Technical Support

Visit Yealink WIKI (<http://support.yealink.com/>) for the latest firmware, guides, FAQ, Product documents, and more. For better service, we sincerely recommend you to use Yealink Ticketing system (<https://ticket.yealink.com>) to submit all your technical issues.

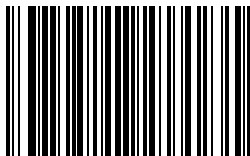

W5 3 P - E N

YEALINK(XIAMEN) NETWORK TECHNOLOGY CO.,LTD.  
Web: [www.yealink.com](http://www.yealink.com)  
Copyright©2018 YEALINK(XIAMEN) NETWORK  
TECHNOLOGY CO.,LTD.All rights reserved.