

Installation Manual (NAVRGB6.0-AR1-NBT+HA12+BTR)

Acura TL 1999-2003

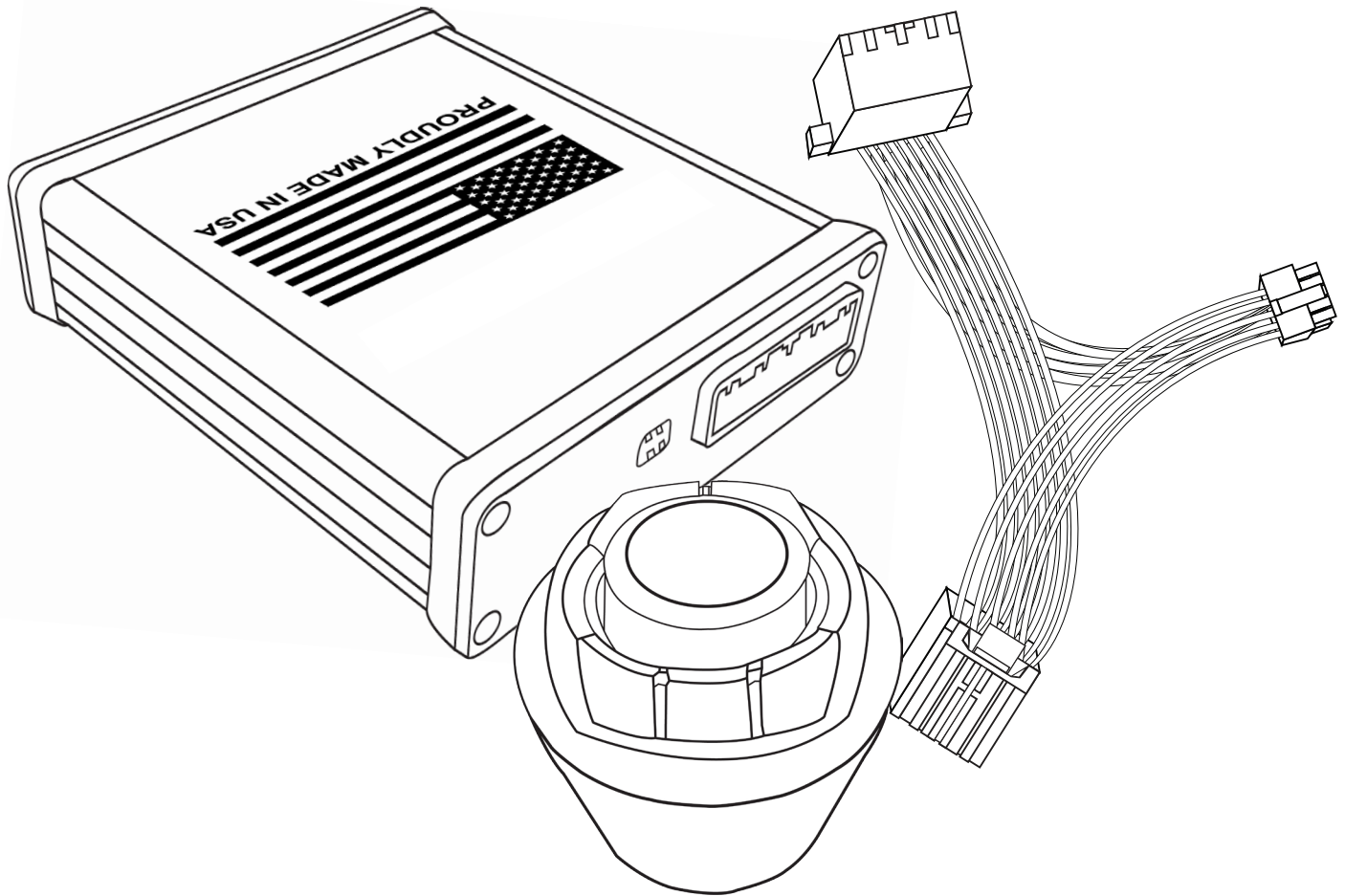

Manual Version: 1.0



NOTICE: We recommend having this installation performed by a certified technician.
All product names, logos, brands, trademarks and registered trademarks are property of their respective owners.

WELCOME

IMPORTANT WARNING

Failure to follow these instructions carefully or not installing the interface as described could cause damage to the vehicle or safety systems on the vehicle. Any interference with specific safety systems could cause harm to other people as well.

This manual provides detailed instructions for this specific interface and vehicle type. Follow them as described. If the installer is not sure or does not feel comfortable, consult a competent technician who has the knowledge, experience, and understanding of how to complete the installation. Failure to do so will void your warranty on your interface and maybe on the vehicle.

Precautions

PLEASE READ BEFORE YOU START THE INSTALLATION

- Please study these instructions carefully before installing the interface.
- Protect the areas of the vehicle you will be working on before starting the disassembly.
- Use painters' tape or equivalent, and use protective blankets or covers on the front seats, interior panels, and center console.
- Do not disconnect the battery if the vehicle has an anti-theft coded radio unless you have the radio code.
- Write down radio code here if applicable _____.
- If installing an external push button switch, go over the location with the vehicle owner and make sure it is in an accessible place.
- To avoid accidental battery drainage, turn off the interior lights or remove the dome light fuse.
- Roll down a window to avoid being locked out of the car.
- Set Parking brake.
- Remove the negative battery cable if necessary.
- Always secure the interface with Velcro or double-sided tape to prevent rattling or damage.
- Make sure that the panels fit correctly.
- Use electrical tape on all your connections and splices, do not leave any exposed wires.
- Route all wires along with factory harnesses. Do not drill or make any unnecessary holes.
- Always use the help of a professional installer to prevent any damage to the vehicle or the interface.

What's In The Box?

Interface
(Part # NAVRGB6.0-AR1-NBT)

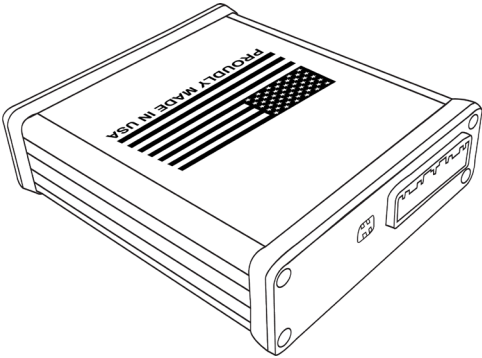

Joystick
(Part # NT-JY1)

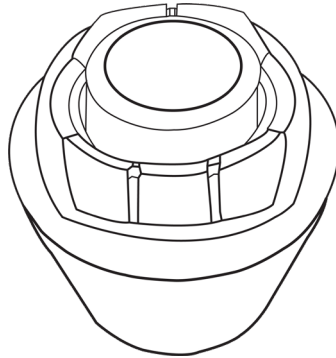

USB Configuration Cable
(Part # NT-USB-CNG)

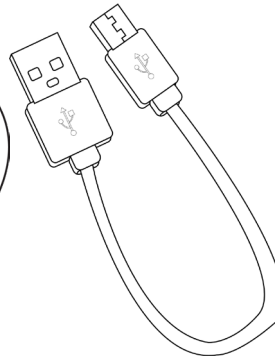

Batteries
(Part # NT-BT-AAA)

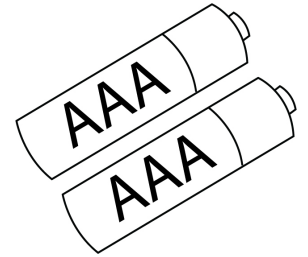

Interface Harness
(Part # NT-WHNT6)

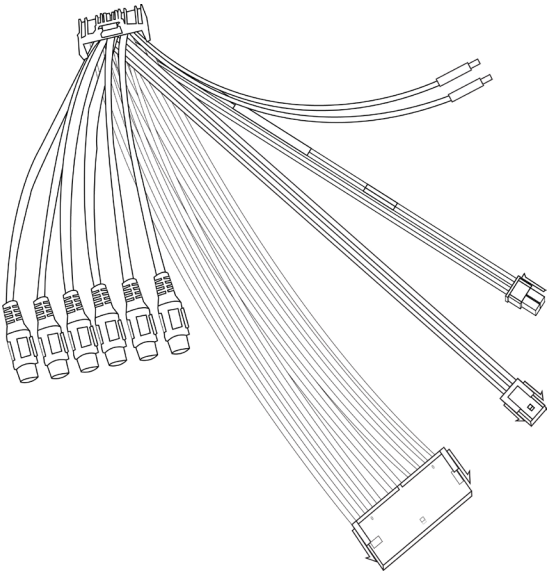

Vehicle Specific
Plug and Play Harness
(Part # NT-HA12)

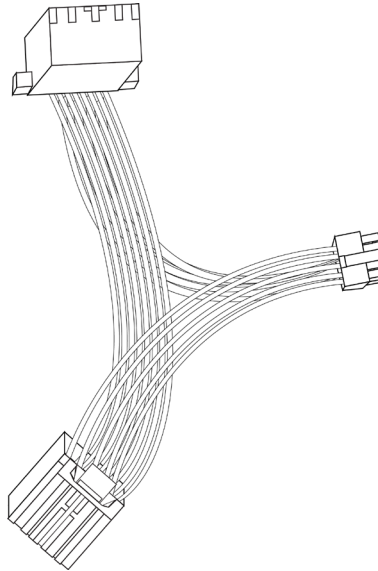

Joystick Receiver
(Part # NT-JYRCV1)

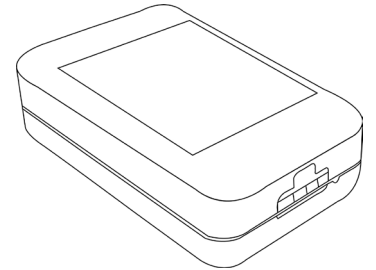

Joystick Receiver Harness
(Part # NT-JYRB1)

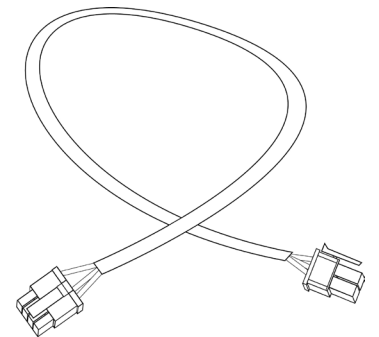

Microphone Cable
(Part # NT-MIC-CBL)

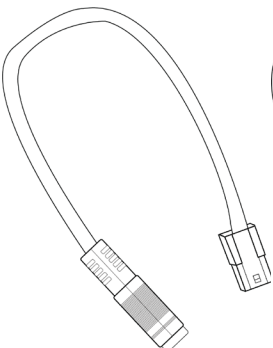

Microphone
(Part # NT-MIC)

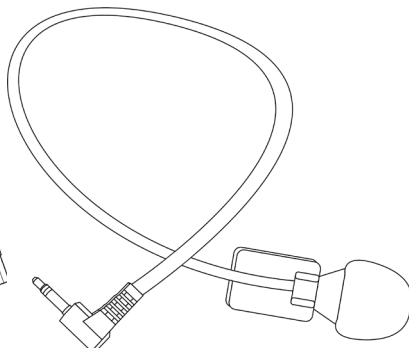

AUX Cable
(Part # NT-AUX-35)

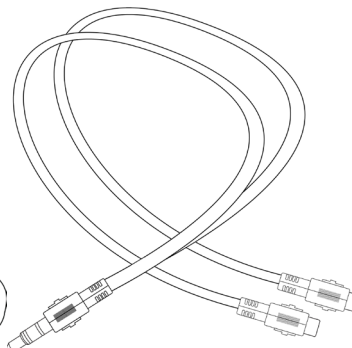

Stereo Cable Extension
(Part # NT-STR-CBLE-EXT)

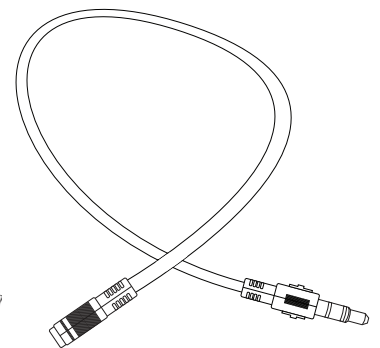

Interface Harness Diagram

Interface Harness
(Part # NT-WHNT6)

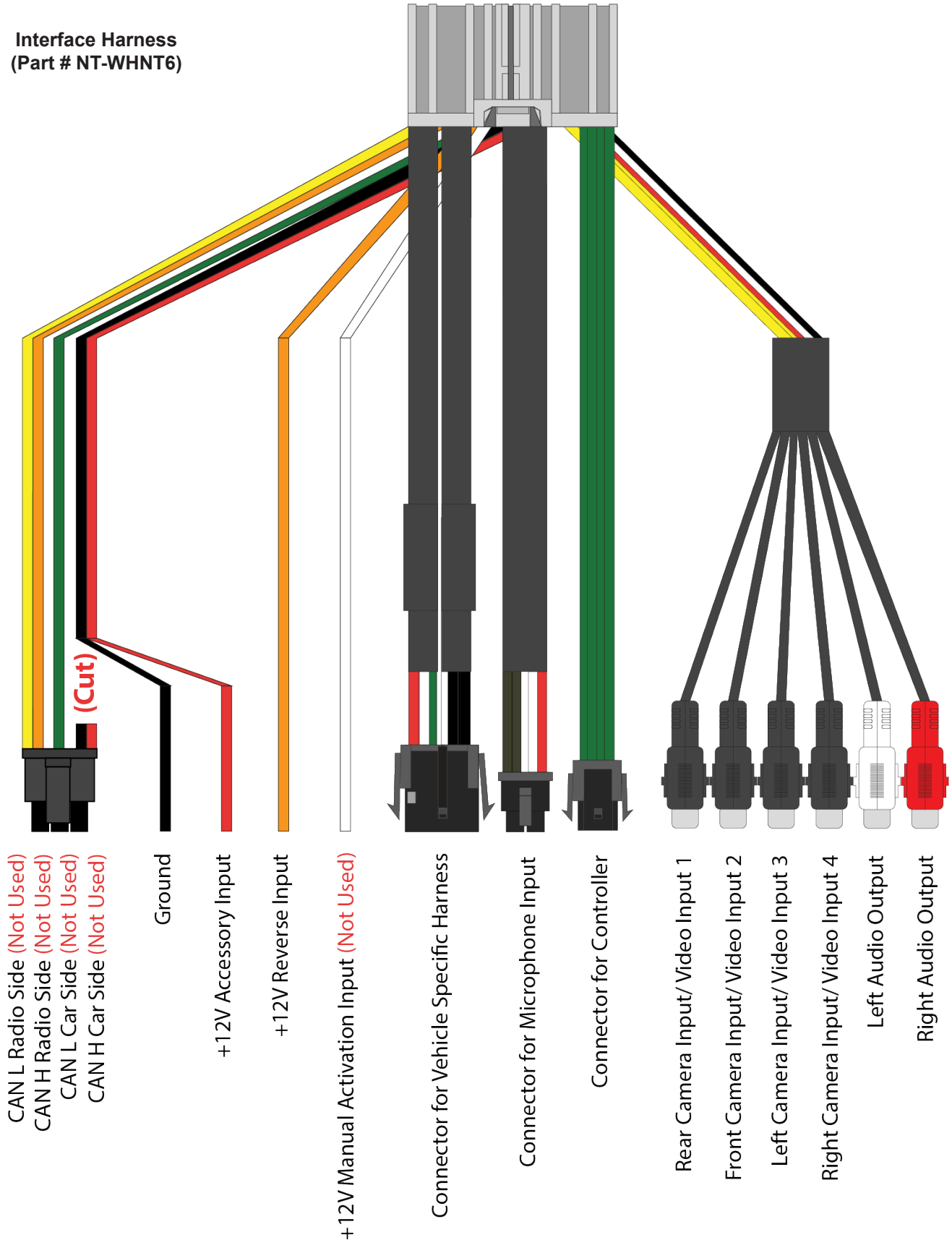

CAN L Radio Side (Not Used)
CAN H Radio Side (Not Used)
CAN L Car Side (Not Used)
CAN H Car Side (Not Used)

Ground
+12V Accessory Input
+12V Reverse Input

+12V Manual Activation Input (Not Used)

Connector for Vehicle Specific Harness
Connector for Microphone Input
Connector for Controller

Rear Camera Input/Video Input 1
Front Camera Input/Video Input 2
Left Camera Input/Video Input 3
Right Camera Input/Video Input 4
Left Audio Output
Right Audio Output

Interface Harness Description

CAN L Radio Side- (Not Used)

CAN H Radio Side- (Not Used)

CAN L Car Side- (Not Used)

CAN H Car Side- (Not Used)

Ground- Black (ground) To vehicle (metal) body.

+12V Accessory Input- Connect this wire to the electric terminal controlled by the ignition switch (12 V DC) ON/OFF. Do not connect this lead to the power source terminals to which power is continuously supplied. If the lead is connected to such terminals, the battery may be drained. (See Installation Instructions section of the manual)

+12V Reverse Input- This is connected so that the interface can detect whether the vehicle is moving forwards or backward. Connect the orange wire to the wire whose voltage changes when the reverse gear is engaged. (See Installation Instructions section of the manual)

+12V Manual Activation Input: (Not Used)

Connector for Vehicle Specific Harness- This connection is dedicated for connecting the vehicle specific plug and play wiring harness.

Connector for Microphone Input- This connection is dedicated to a factory or supplied microphone input. (See Installation Instructions section of the manual).

Connector for Controller- This connection is dedicated to connecting the factory rotary/joystick or supplied IR Remote.

Rear Camera Input / Video Input 1- This input is dedicated for an aftermarket rearview camera or a video source with an RCA video output. Your vehicle's factory camera will continue to work as before without any changes. (If the vehicle is equipped with that option)

Front Camera Input / Video Input 2- This input is dedicated for an aftermarket front view camera or a video source with an RCA video output. Your vehicle's factory camera will continue to work as before without any changes. (If the vehicle is equipped with that option)

Left Camera Input / Video Input 3- This input is dedicated for an aftermarket left view camera or a video source with an RCA video output. Your vehicle's factory camera will continue to work as before without any changes. (If the vehicle is equipped with that option)

Right Camera Input / Video Input 4- This input is dedicated for an aftermarket right view camera or a video source with an RCA video output. Your vehicle's factory camera will continue to work as before without any changes. (If the vehicle is equipped with that option)

Left Audio Output- Connect the Audio output RCAs to the AUX input on the vehicle. If needed use either the extension cable or RCA to 3.5 mm jack adaptor (if supplied) to make the connections. (See Installation Instructions section of the manual).

Right Audio Output- Connect the Audio output RCAs to the AUX input on the vehicle. If needed use either the extension cable or RCA to 3.5 mm jack adaptor (if supplied) to make the connections. (See Installation Instructions section of the manual).

Interface Diagram and Description

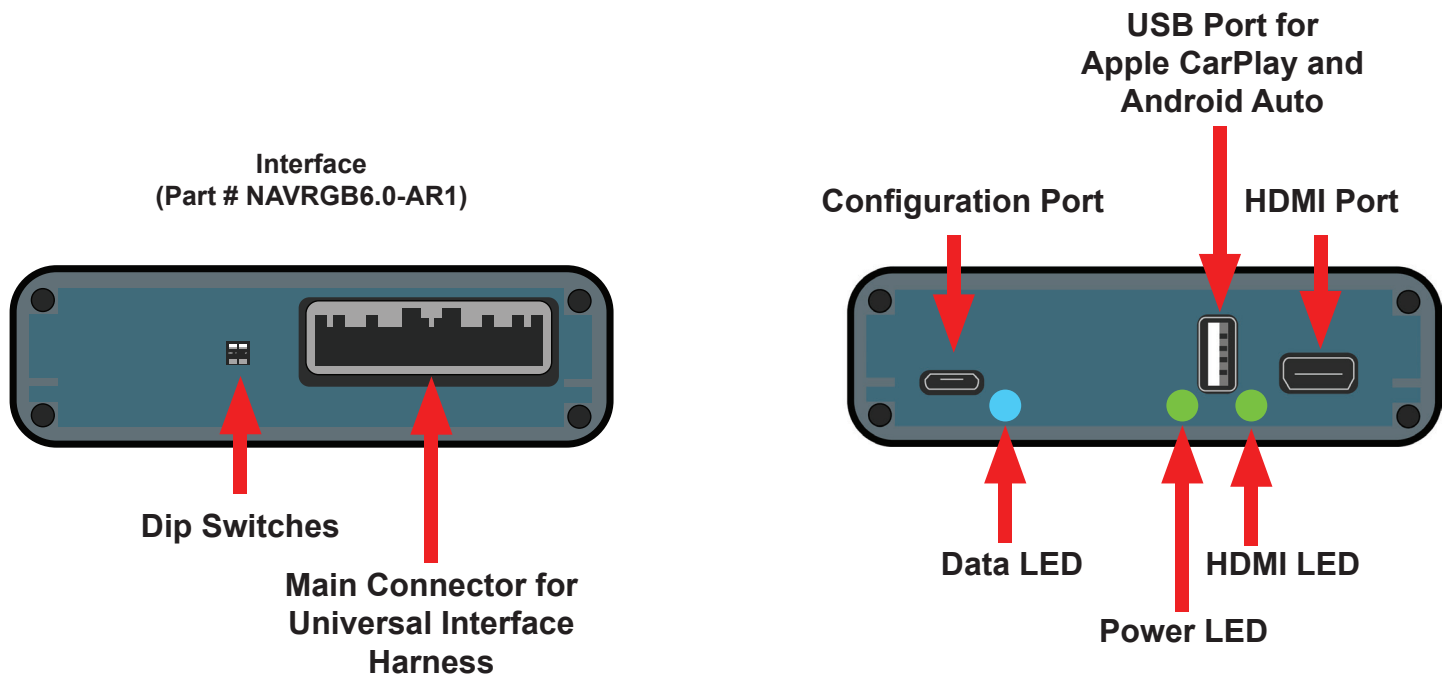

Main Connector for Universal Interface Harness- This port is dedicated for a connection of a universal wiring harness.

Dip Switches- Set dip switches to the ON or OFF position (See Installation Instructions section of the manual).

Configuration Port- This USB port is dedicated for the interface configuration only.

Data LED- Normal operation of the interface must have blue LED blinking. If the blue LED is not blinking, the interface is not receiving data from the vehicle and the interface will not operate properly.

Power LED- Normal operation of the interface must have a green LED ON. If the green LED is not ON, the interface is not receiving power and the interface will not work. Your vehicle radio may also stay OFF.

HDMI LED- Normal operation of the interface must have a green LED ON. If the green LED is not ON, the interface HDMI is not receiving power. If the green LED is not ON, the interface HDMI port will not work.

USB Port for Apple CarPlay and Android Auto- This USB port is for a hard-wire connection of a smartphone. This USB port also provides charging for the smartphone. This connection is not required if Apple CarPlay and Android Auto is done via the wireless connection. *(Do not use this USB port to power up HDMI streaming devices such as Roku, FireStick, Chromecast, or similar devices because damage to the unit can occur.)*

HDMI Port- This port is dedicated for connecting video sources such as iPhone mirroring, Android Mirroring, Apple TV, Roku, FireStick, Chromecast, PlayStation, Xbox, or similar devices.

Interface Configuration

NO SOFTWARE APPLICATION DOWNLOAD IS REQUIRED TO CONFIGURE THE INTERFACE.

To configure the interface, you must use Windows, Mac, or Google computer.

Windows computers must use the latest version of Google Chrome or Microsoft Edge browser.

Mac computers must use the latest version of the Google Chrome browser.

Google computers must use the latest version of the Google Chrome browser.

TO CONFIGURE THE INTERFACE, GO TO [HTTPS://CONFIG.NAVTOOL.COM](https://config.navtool.com)

Connect the interface to the computer using supplied USB Configuration Cable (Part # NT-USB-CNG)

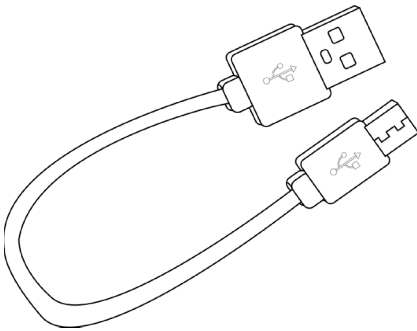

Configuration Port

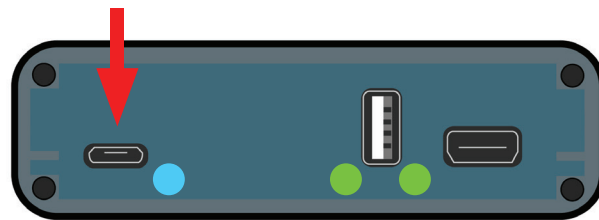

SCAN ME

To see a video of the configuration process
Scan QR-Code or go to
https://youtu.be/iES_rW240X0

Quick Connection Diagram

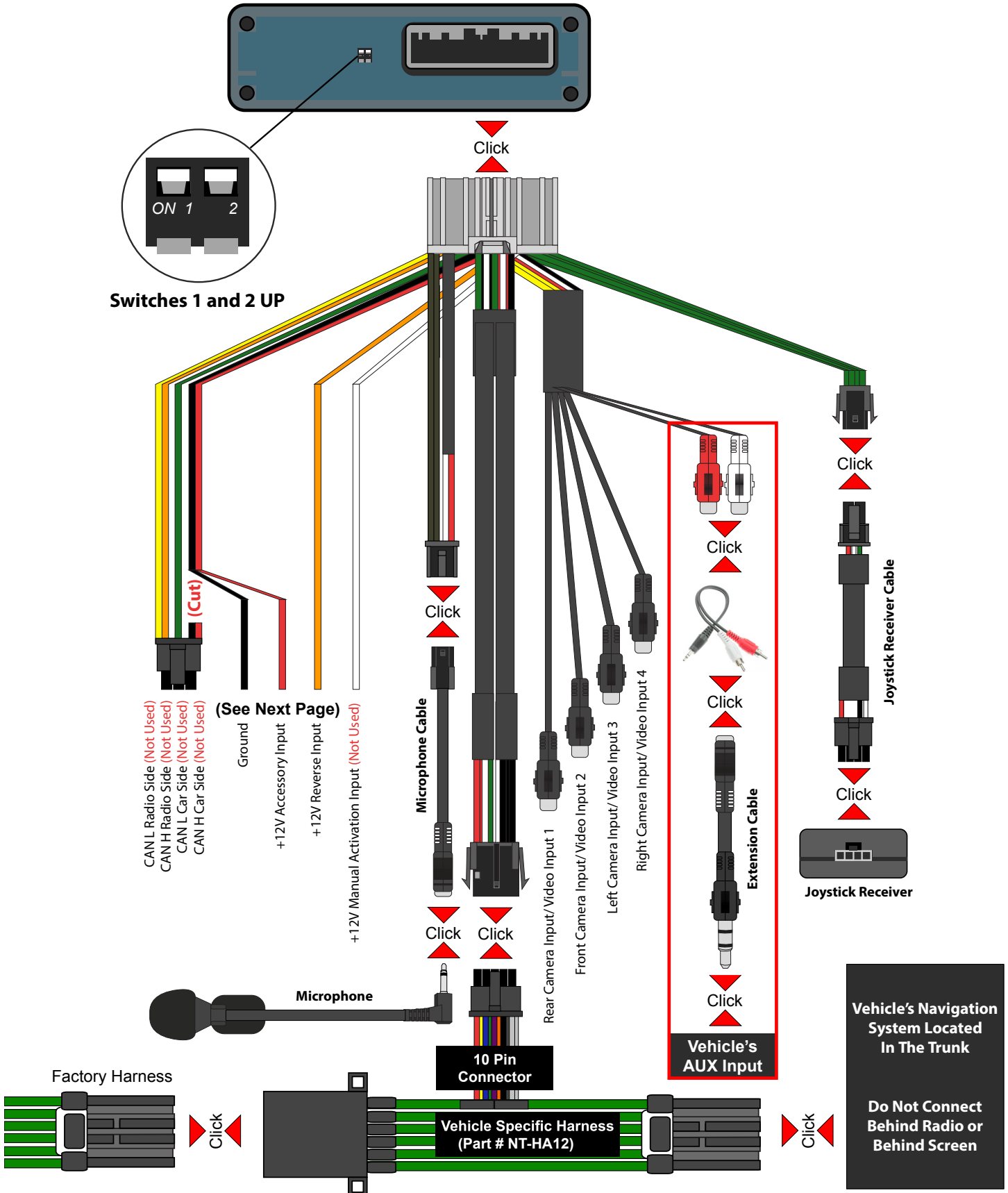

Installation Instructions

Step 1: Locate the vehicle's DVD-ROM Navigation System. (Disassembly may or may not be required depending on the car)

Step 2: Disconnect the Black 12 Pin Connector from the back of the Vehicle's Navigation System.

Step 3: Connect the female end of the Supplied Vehicle Specific Harness HA12 to your disconnected factory harness. Connect the male end of the Supplied Vehicle Specific Harness HA12 into the back of the Vehicle's Navigation System (where you disconnected the factory plug).

Step 4: Connect the 10-pin connectors on the Interface harness and the vehicle-specific harness HA12. (See Page 8).

Step 5: Cut off the Red (+12 Volts ACC) and Black (Ground) wires off the 6-pin plug on the interface harness (See Page 8) and connect directly to the 8-pin factory harness. (See the image shown below)

Step 6: Connect the Orange wire (+12 Volt Reverse Input) to the factory reverse wire in the 8-pin harness only if your are adding an aftermarket reverse camera. (See the image Shown below)

Step 7: Connect Red and White RCA jacks. Connect Red to Red. Connect White to White. Then plug the AUX jack into the vehicle's AUX input. (Use the supplied extension cable Part # NT-STR-CBLE-EXT if needed)

Step 8: Connect the supplied Joystick Receiver Harness to the remote plug input on the Interface Harness. Plug the Joystick Receiver Harness into the Joystick Receiver. (See Page 8)

Step 9: Connect the supplied Microphone Cable to the microphone plug input on the Interface Harness. Plug the supplied Microphone into the Microphone Cable. Place Microphone in an unobstructed central location in the cabin of the vehicle. (See Page 8)

Step 10: Make sure both dip switches are "UP" in the off position. Then plug in the main harness into the interface. (See Page 8). *Optional, connect your HDMI device to the back of the interface. Connect aftermarket cameras or video source to the video input RCAs on the interface harness.*

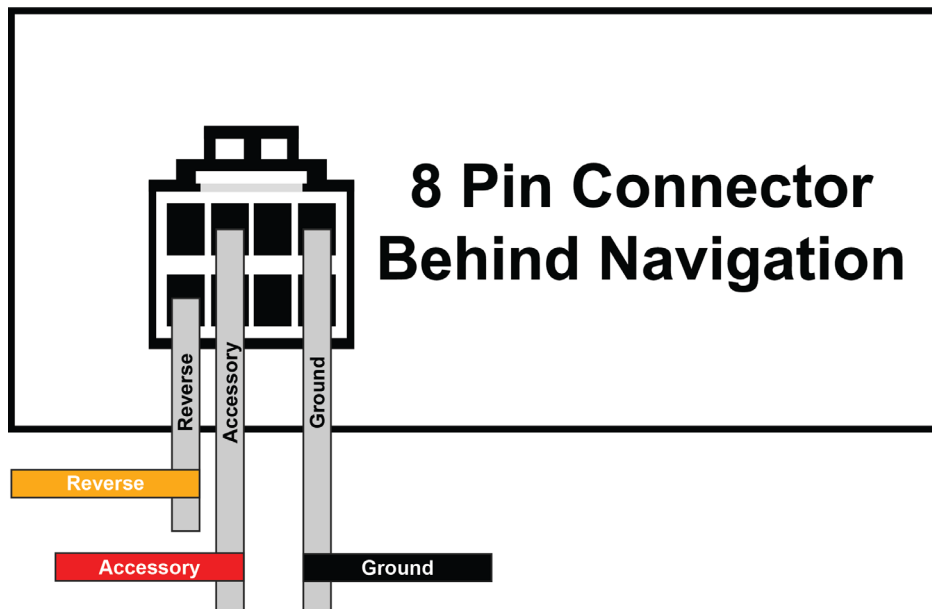

Activating The Interface

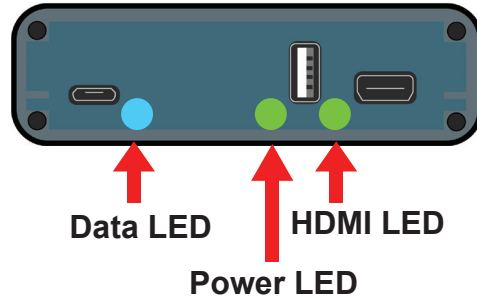

Step 1: Start the vehicle, the interface should have one blinking blue LED and two steady lit green LED lights.

At this time, your car radio should boot up into its initial state, and the radio should be working. Please check that the radio operates appropriately. All radio functions are working, including CD, Satellite Radio, AM/FM radio, audio plays from car speakers, and all other radio features.

If the interface LED lights do not light up or are blinking red, make sure everything is connected properly.

Step 2: Set the vehicle's radio to AUX or an alternative AUX input device.

Interface audio will not play through car speakers if AUX is not connected or radio is not set to AUX input.

Step 3: Press and hold the back button on the supplied remote for 3-5 seconds to turn on and off the interface.

If the interface is not displaying on the screen, please check that the remote control back lit buttons light up and the LED on the joystick receiver blinks when pressing any buttons. If it does not light up, twist open the lid of the remote. Open the battery door and insert or replace batteries.



Remote Operation Guide

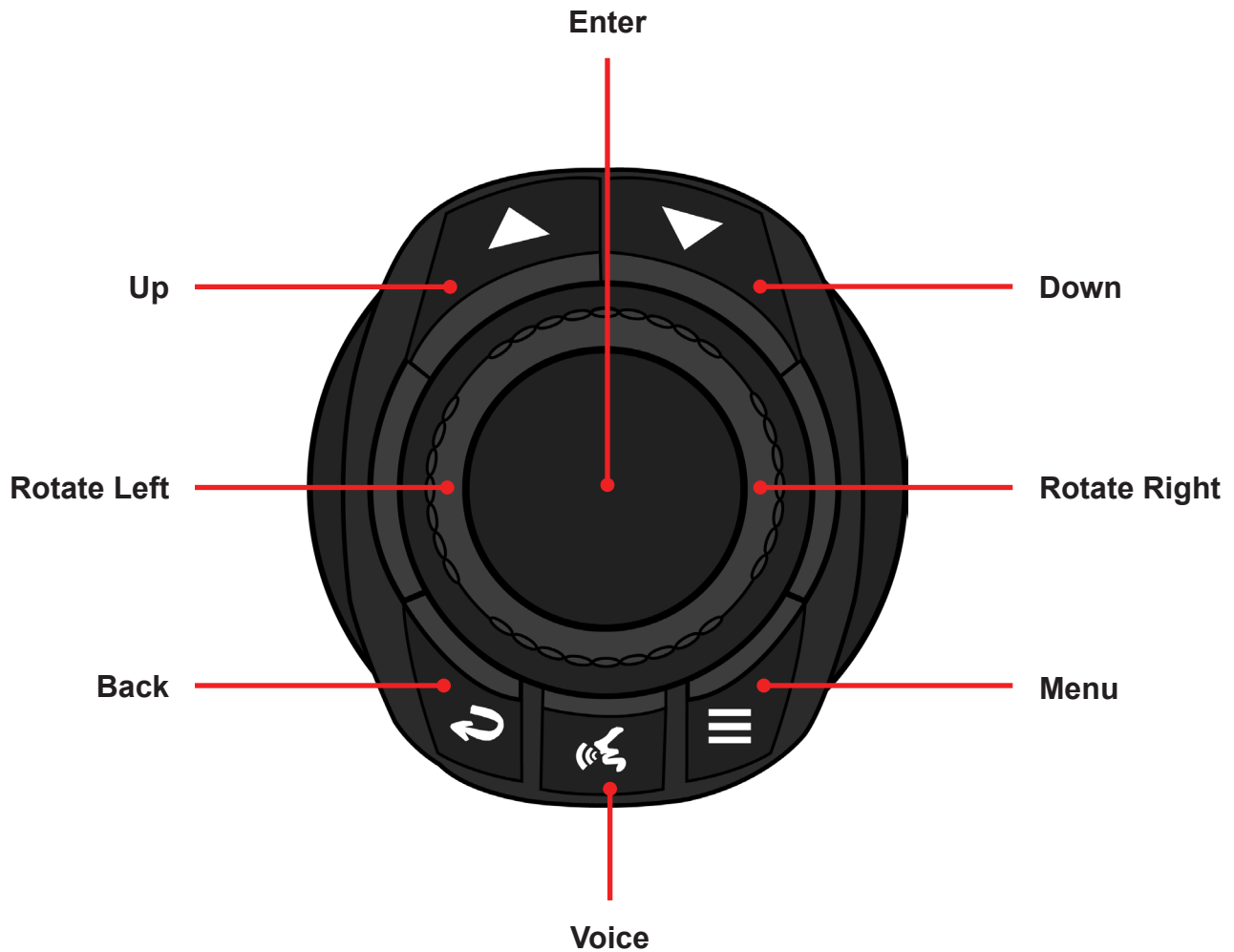

Up- Press to go UP inside of Apple CarPlay or Android Auto.

Down- Press to go DOWN inside of Apple CarPlay or Android Auto.

In Android Auto, DOWN button is used to enter the bottom menu bar of Android Auto.

Rotate Left- To go LEFT inside Apple CarPlay, Android Auto, and the interface menu.

Rotate Right- To go RIGHT inside Apple CarPlay, Android Auto, and the interface menu.

Back- Press to go back inside Apple CarPlay or Android Auto.

Press and hold for 3-5 seconds to turn the interface ON or OFF.

Voice- Press to activate Siri or Ok Google.

Menu- Brings up the interface's bottom menu to change inputs or go into settings.

Enter- ENTER button

Testing and Settings

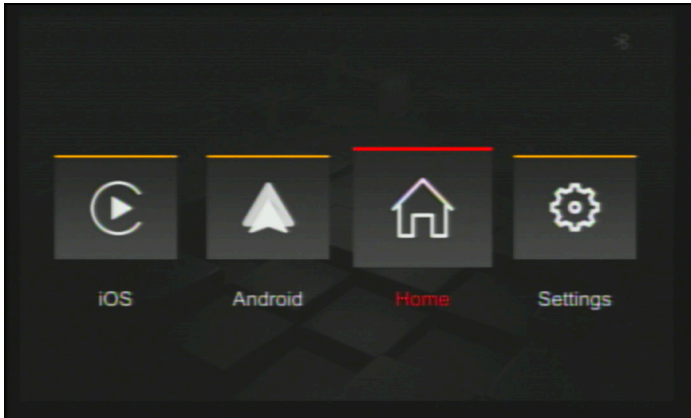

Press and hold the back button on the supplied remote for 3-5 seconds to activate the interface. If your screen looks like the image shown on the left, press the menu button on the supplied remote. The bottom interface menu bar will appear. Your screen should now look like the image on the right.

Note: You can also rotate the remote control wheel and select the Home Icon to access the bottom interface menu bar.

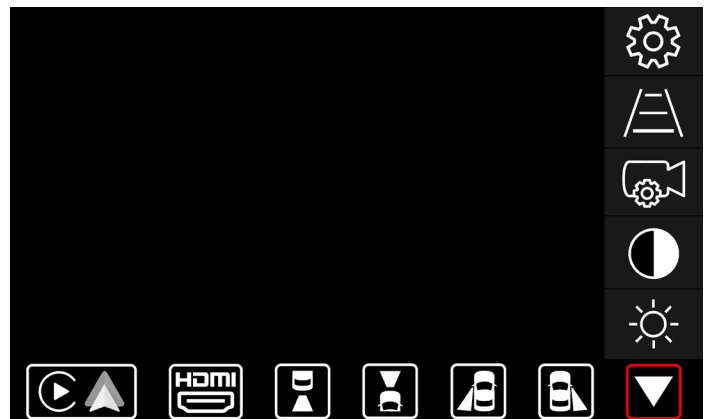
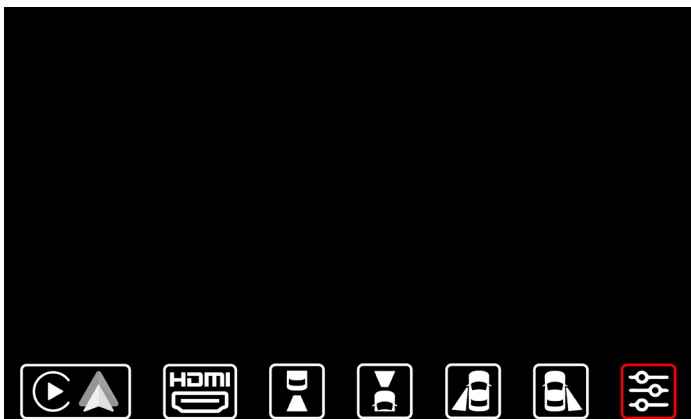

Rotate the wheel on the supplied remote control to the right and select Settings. (see left image) Press the Enter button on the supplied remote to access different Interface Settings and Features. (see right image)

A drop down menu will appear that will let you change different interface settings features. (Brightness, Contrast, Camera Settings, Parking Line Settings, Miscellaneous settings)

Rotate the wheel on the supplied remote control left or right to navigate the menu bar. **(Up and Down buttons on the supplied remote do not apply)**

Note: Pressing the Enter button on the supplied remote while the Down Triangle is selected (see right image) will close the interface settings menu bar.



Brightness (Up and Down buttons on the supplied remote control do not apply)

Rotate the wheel on the supplied remote control and select Brightness. *(see left image)*
 Press the Enter button on the supplied remote to enter the Brightness Setting. *(see right image)*

The white bar in the middle shows the current brightness.
 Rotate the wheel on the supplied remote to select the +Plus or -Minus icon.
 Press the Enter button on the supplied remote to increase or decrease the brightness.
 Save or Cancel your changes.

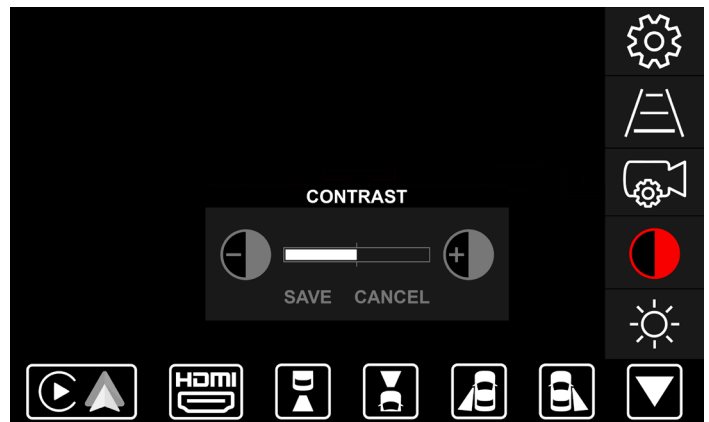
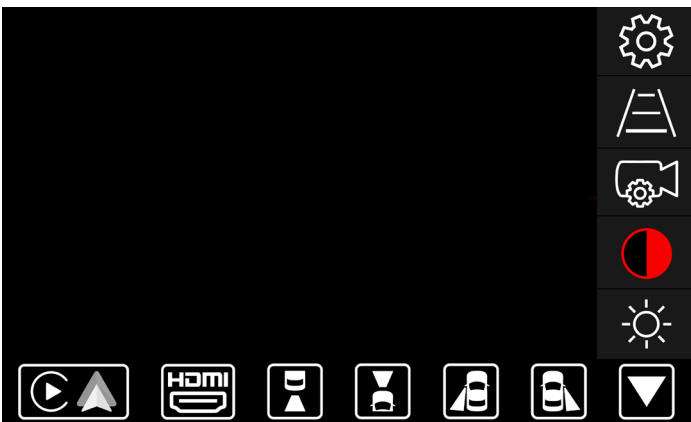

Contrast (Up and Down buttons on the supplied remote control do not apply)

Rotate the wheel on the supplied remote control and select Contrast. *(see left image)*
 Press the Enter button on the supplied remote to enter the Contrast Setting. *(see right image)*

The white bar in the middle shows the current contrast.
 Rotate the wheel on the supplied remote to select the +Plus or -Minus icon.
 Press the Enter button on the supplied remote to increase or decrease the contrast.
 Save or Cancel your changes.

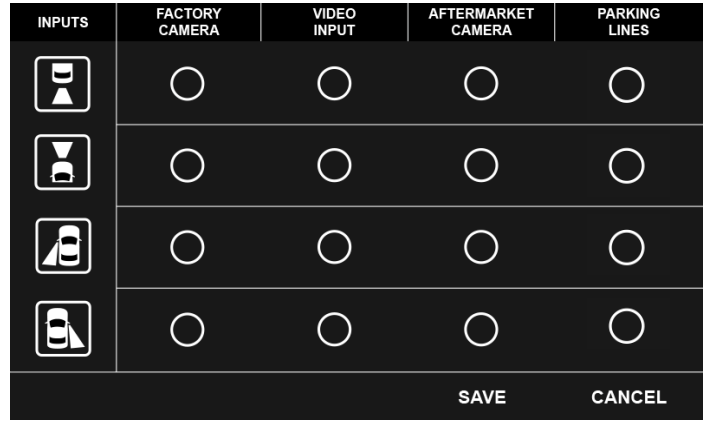

Camera Settings (Up and Down buttons on the supplied remote control do not apply)

Rotate the wheel on the supplied remote control and select Camera Settings. (see left image)
 Press the Enter button on the supplied remote to enter the Camera Settings Menu. (see right image)

Rotate the wheel on the supplied remote control left or right to select your camera inputs.
 (Rear Camera, Front Camera, Left Camera, Right Camera).

Press the Enter button on the supplied remote control multiple times on the selected camera input to cycle through its different input options.
 (Factory Camera, Video Input, Aftermarket Camera, Parking Lines)

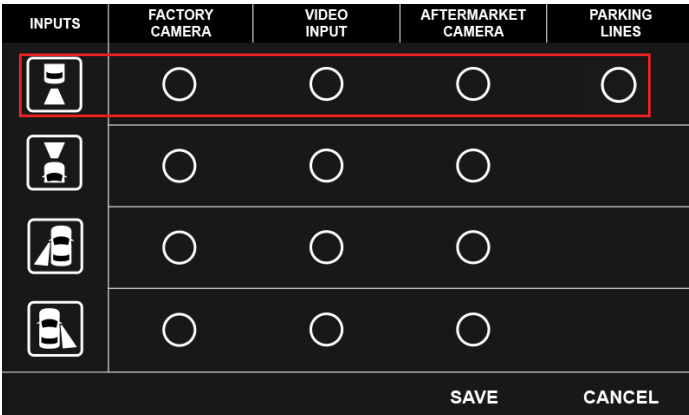

Factory camera: Select this option if your vehicle is equipped with a factory installed rear view camera.

Video input: Select this option if your vehicle is not equipped with a factory rear view camera and you are not planning to add a aftermarket camera or if you wish to use this input as a video input.

Aftermarket camera: Select this option if you are installing an aftermarket rear view camera.

Parking lines: Select this option if you are installing an aftermarket rear view camera and you wish to add distance lines to the camera image.

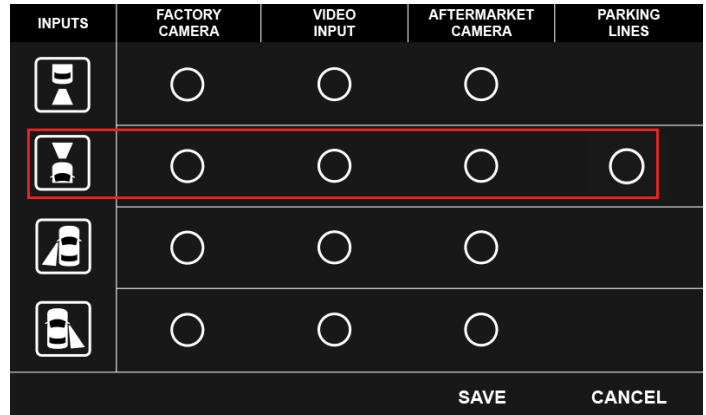

Factory camera: Select this option if your vehicle is equipped with a factory installed forward facing camera. Do not select this option if your vehicle is equipped with 360 degree parking cameras, 360 degree front parking camera is not considered forward facing camera.

Video input (Select for most installations): Select this option if your vehicle is not equipped with a factory forward facing camera and you are not planning to add a aftermarket camera or if you wish to use this input as a video input.

Aftermarket camera: Select this option if you are installing an aftermarket forward facing camera.

Parking lines: Select this option if you are installing an aftermarket forward facing camera and you wish to add distance lines to the camera image.

INPUTS	FACTORY CAMERA	VIDEO INPUT	AFTERMARKET CAMERA	PARKING LINES
	<input type="radio"/>	<input type="radio"/>	<input type="radio"/>	
	<input type="radio"/>	<input type="radio"/>	<input type="radio"/>	
	<input type="radio"/>	<input type="radio"/>	<input type="radio"/>	<input type="radio"/>
	<input type="radio"/>	<input type="radio"/>	<input type="radio"/>	
		SAVE		CANCEL

Factory camera: Select this option if your vehicle is equipped with a factory installed left lane watch camera. Do not select this option if your vehicle is equipped with 360 degree parking cameras, 360 degree front parking camera is not considered forward facing camera.

Video input (Select for most installations): Select this option if your vehicle is not equipped with a factory left lane watch camera and you are not planning to add a aftermarket camera or if you wish to use this input as a video input.

Aftermarket camera: Select this option if you are installing an aftermarket left lane watch camera.

Parking lines: Select this option if you are installing an aftermarket left lane watch camera and you wish to add distance lines to the camera image.

INPUTS	FACTORY CAMERA	VIDEO INPUT	AFTERMARKET CAMERA	PARKING LINES
	<input type="radio"/>	<input type="radio"/>	<input type="radio"/>	
	<input type="radio"/>	<input type="radio"/>	<input type="radio"/>	
	<input type="radio"/>	<input type="radio"/>	<input type="radio"/>	
	<input type="radio"/>	<input type="radio"/>	<input type="radio"/>	<input type="radio"/>
		SAVE		CANCEL

Factory camera: Select this option if your vehicle is equipped with a factory installed right lane watch camera. Do not select this option if your vehicle is equipped with 360 degree parking cameras, 360 degree right parking camera is not considered forward facing camera.

Video input (Select for most installations): Select this option if your vehicle is not equipped with a factory right lane watch camera and you are not planning to add a aftermarket camera or if you wish to use this input as a video input.

Aftermarket camera: Select this option if you are installing an aftermarket right lane watch camera.

Parking lines: Select this option if you are installing an aftermarket right lane watch camera and you wish to add distance lines to the camera image.

If your vehicle is equipped with a factory 360 degree parking camera, set your rear camera to factory camera. Set front, left, and right cameras to video input.

INPUTS	FACTORY CAMERA	VIDEO INPUT	AFTERMARKET CAMERA	PARKING LINES
	<input checked="" type="radio"/>	<input type="radio"/>	<input type="radio"/>	
	<input type="radio"/>	<input checked="" type="radio"/>	<input type="radio"/>	<input type="radio"/>
	<input type="radio"/>	<input checked="" type="radio"/>	<input type="radio"/>	<input type="radio"/>
	<input type="radio"/>	<input checked="" type="radio"/>	<input type="radio"/>	<input type="radio"/>
		SAVE		CANCEL

Adjust Camera Settings based on equipment installed in the vehicle.

Save or cancel your changes.

Image on the left shows a typical installation of the interface done on a vehicle that has a factory rear view camera that is not equipped with any other factory or aftermarket cameras.

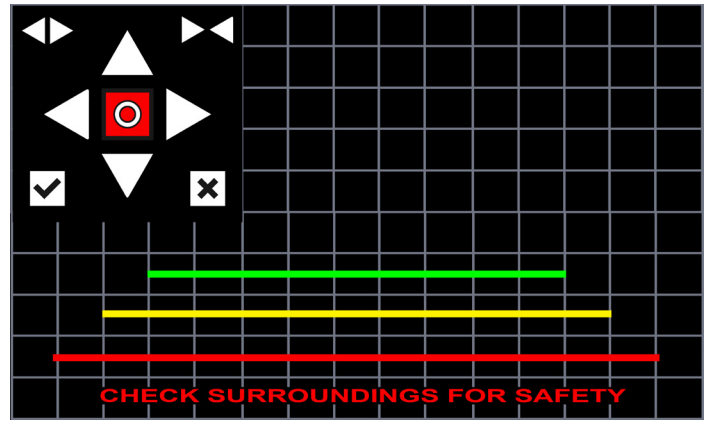

Parking Line Settings (Up and Down buttons on the supplied remote control do not apply)



Select the camera input on the bottom interface menu bar that you want to make parking line changes to before entering Parking Line Settings.

Rotate the supplied remote and select Parking Line Settings. (see left image)

Press Enter on the supplied remote to enter the Parking Line Settings Menu. (see right image)

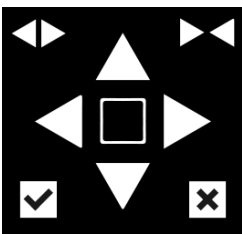

- Green Parking Line
- Yellow Parking Line
- Red Parking Line
- Green Parking Line Selected
- Yellow Parking Line Selected
- Red Parking Line Selected

Rotate the supplied wheel on the remote control left or right to navigate the Parking Line Settings Menu. (Parking Line Color, Up, Down, Left, Right, Increase Line Width, Decrease Line Width, Save, Cancel)

The colored square in the middle shows what color parking line you are making changes to. Select the colored square in the middle and press the Enter button on the supplied remote to change color.

Save or cancel your changes.



MISCELLANEOUS SETTINGS	ON	OFF
APPLE CARPLAY / ANDROID AUTO (AUTO ON MODE)	<input type="radio"/>	<input type="radio"/>
INTERFACE AUDIO SOUND	<input type="radio"/>	<input type="radio"/>
MANUAL ACTIVATION WIRE AS REVERSE TRIGGER +12V	<input type="radio"/>	<input type="radio"/>
	SAVE	CANCEL

Miscellaneous Settings (Up and Down buttons on the supplied remote control do not apply)

Rotate the wheel on the supplied remote control and select the Settings Gear. (see left image)
 Press the Enter button on the supplied remote control to enter the Miscellaneous Settings Menu. (see right image)

Rotate the wheel on the supplied remote control left or right to highlight the Miscellaneous Settings that you want to adjust.

Press the Enter button on the supplied remote control to turn ON/OFF the setting.

Save or cancel your changes.

MISCELLANEOUS SETTINGS	ON	OFF
APPLE CARPLAY / ANDROID AUTO (AUTO ON MODE)	<input type="radio"/>	<input type="radio"/>
INTERFACE CHIRP SOUND	<input type="radio"/>	<input type="radio"/>
MANUAL ACTIVATION WIRE AS REVERSE TRIGGER +12V	<input type="radio"/>	<input type="radio"/>
	SAVE	CANCEL

Set this feature to ON if you want to enter Apple CarPlay/Android Auto mode when activating the interface, and bypassing the interface menu.

Set this feature to OFF if you want to enter Interface menu upon activation of the interface.

Turn this feature to ON to enable audio feedback from the interface when activating the interface or when smartphone wireless connection is established.

Turn this feature to OFF if audio feedback from the interface is not required.

Turn ON manual activation wire as reverse trigger if your manual tells you to or if done by an installer. Do not change if they have set this to on.

Turn OFF: Most vehicles will have manual activation wire turned off. Do not change unless your manual tells you or if done by an installer.

Manual Activation Wire as Reverse Trigger +12V should be set to OFF.

Testing HDMI Input

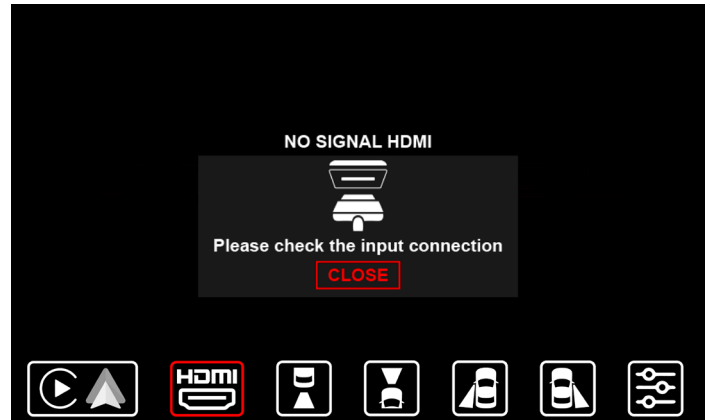

HDMI

Rotate the wheel on the supplied remote control and select HDMI Input. *(if connected)*
Press the Enter button on the supplied remote control to view the HDMI Input.
Press the Menu button on the supplied remote control to access the bottom interface menu bar.

Note: If no HDMI device is connected to the interface, you will see a No Signal HDMI message. Press the Enter button on the supplied remote control to Exit the No Signal HDMI message.

Testing Camera / Video Input

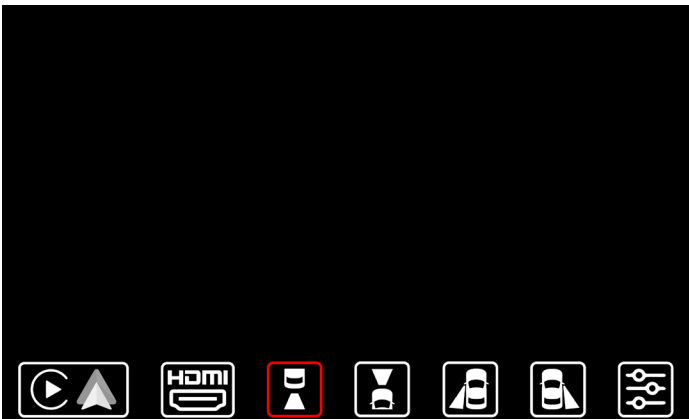

Cameras / Video Input

Rotate the wheel on the supplied remote control and select Camera / Video Inputs. *(if installed)*
Press the Enter button on the supplied remote control to view the selected Camera / Video Input.

Note: If the vehicle has factory cameras such as a factory rear view camera, you will not be able to manually view them from here.

Audio Settings Configuration



Select Apple CarPlay/Android Auto on the bottom left of the interface menu bar.

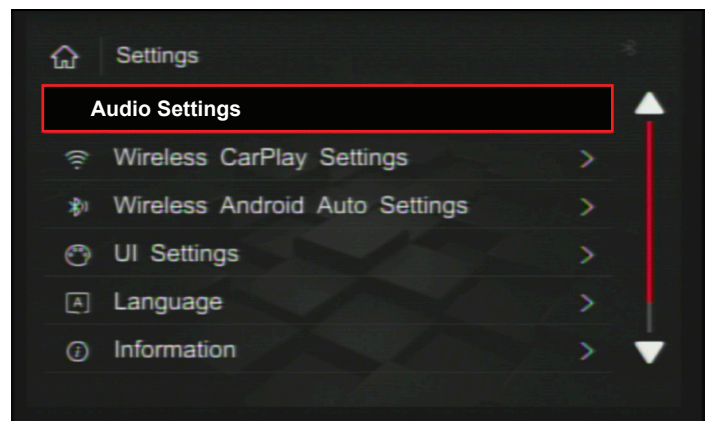
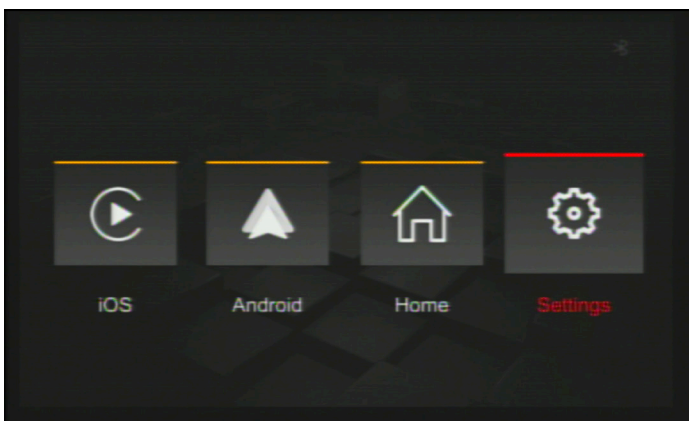

After Selecting Apple CarPlay/Android Auto, you will be brought to this screen. (See left image) Go to Settings and select Audio Settings (See right image)

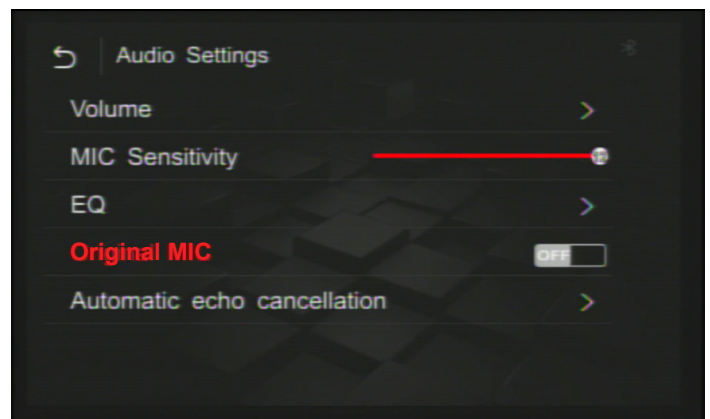
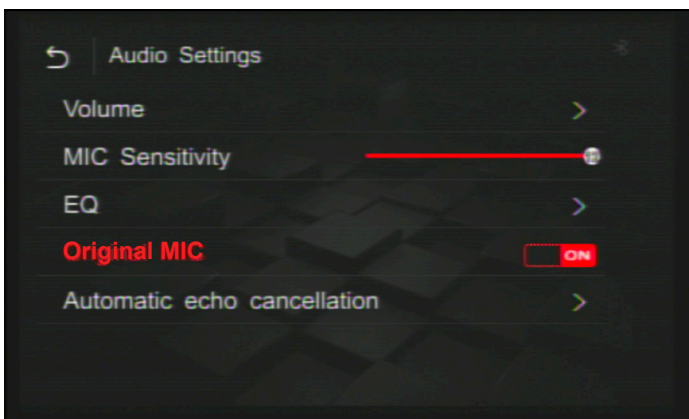

Turn Original MIC OFF

Select the back arrow on the top left of the screen to go back to the previous Settings Menu.

Connecting Your Phone to Apple CarPlay / Android Auto

Disconnect your phone from the vehicle's factory Bluetooth before connecting your phone to the interface. Go to the Bluetooth settings of your phone and select **Forget This Device**.

Follow the diagram below to connect your phone. Make sure your phone's Wifi and Bluetooth are on. Connect to the Bluetooth name of the interface on the CarPlay / Bluetooth Setting of your phone.

iPhone: General > Settings > CarPlay > Connect

Android: Settings > Bluetooth > Connect

Apple CarPlay

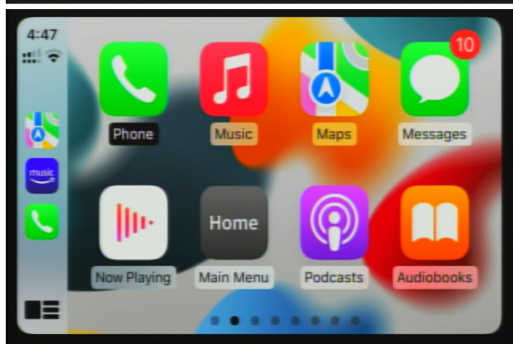
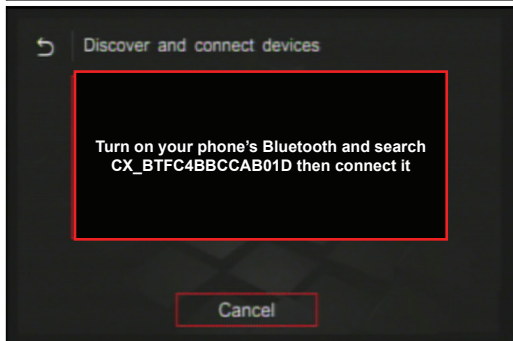
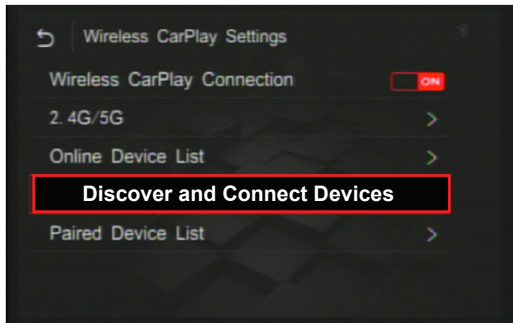
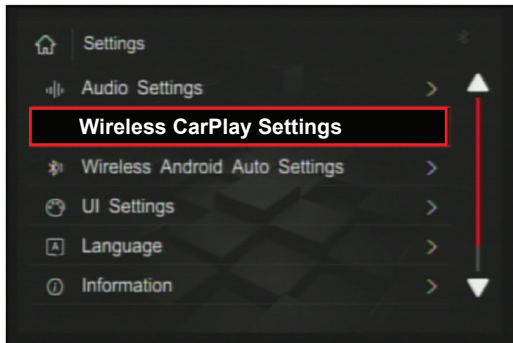

Android Auto

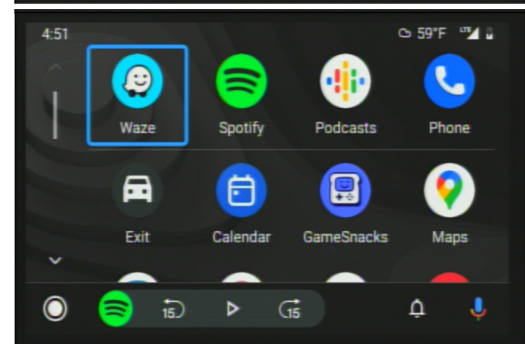
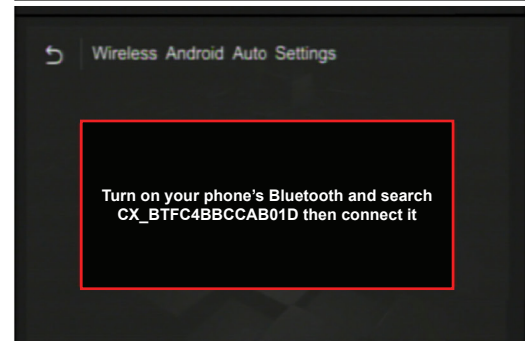
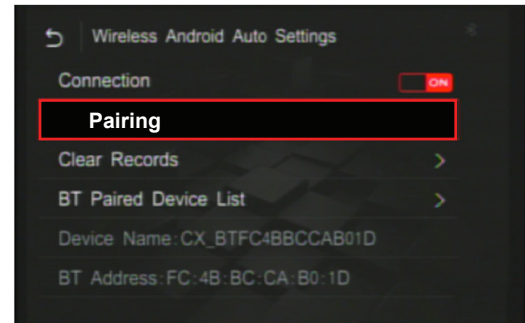
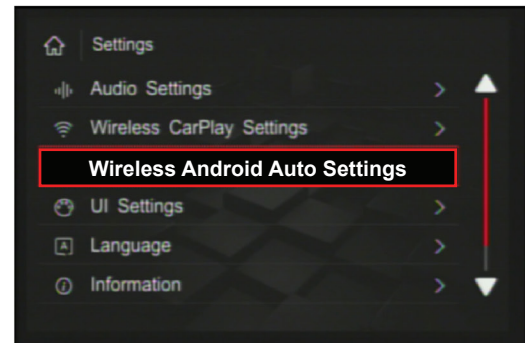

Testing Apple CarPlay / Android Auto

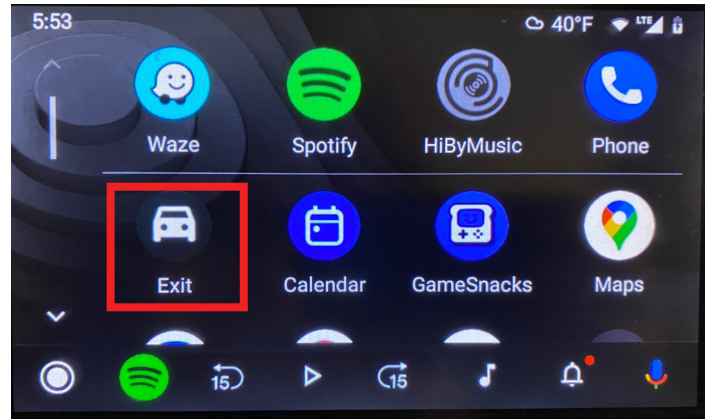
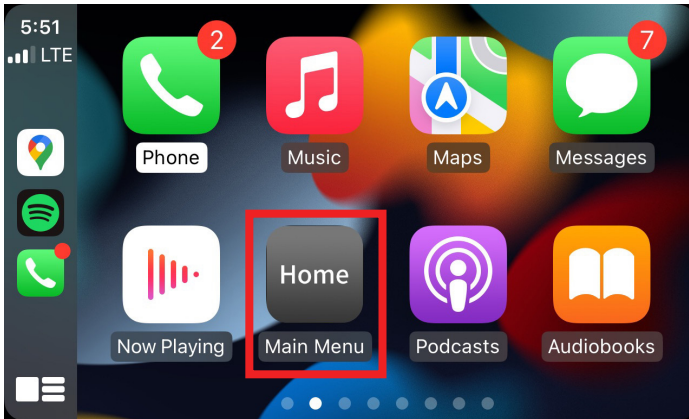

Do a test call once your phone is connected to the interface.

Confirm that the microphone is working and that audio is coming out of the vehicle speakers.

Microphone will not work if the Original MIC setting is not set correctly.

Audio will not play from the vehicle's speakers if the radio is not set to AUX.

To access the bottom interface menu bar

Press the Menu button or press and hold the Back button for 3-5 seconds on the supplied remote. This will make the bottom interface menu bar appear.

To Exit the interface and return to your vehicle's factory menu

Once you have access to the bottom interface menu bar, you can press and hold the Back button for 3-5 seconds on the supplied remote to exit the interface returning you to the vehicle's factory screen.

To Exit Apple CarPlay / Android Auto and return to your vehicle's factory menu

Apple CarPlay- Select the Main Menu App

Android Auto- Select the Exit App

You will not have access to the Apple CarPlay / Android Auto Settings Menu once paired

If you need to go back and make any changes to the Apple CarPlay / Android Auto Settings, set Apple CarPlay/Android Auto (Auto On Mode) to OFF in the Interface Miscellaneous Settings or disconnect your phone from the interface or turn off your phone's Wifi and Bluetooth.

See Interface Menus and Settings section of the manual for details about different settings options.

Vehicle Reassembly Checklist

When performing vehicle reassembly, please make sure to go over the list and check off check mark boxes:

- Check to see if all connectors behind the screen, radio, HVAC etc. were reconnected.
- Check that LCD screen shuts off with the key off, and turns back on with the key on.
- Check touchscreen operation.
- Check Heat and AC controls operation.
- Check AM/FM/SAT radio reception.
- Check CD player/changer operation.
- Check GPS signal reception.
- Check cigarette lighter or +12V power source for accessory or constant power.
- Check to see if any other panels that were removed during installation and now being reassembled have all and any electrical connectors reconnected.
- Turn on parking light and check all dashboard lights operation.
- Check all panels for proper fitting.

Interface Menus and Settings



Interface Screen

After activating the interface, you will be brought to this screen that you can navigate with the factory joystick remote.



Apple CarPlay/Android Auto

Press enter button on joystick to enter this option.

After selecting Apple CarPlay/Android Auto you will be brought to your Apple CarPlay/Android Auto screen.

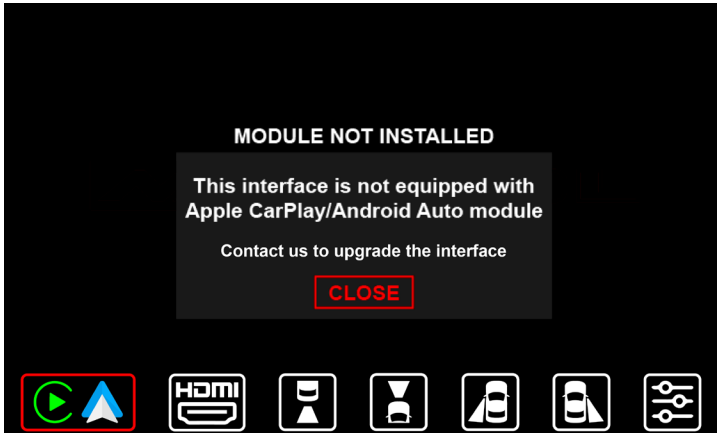

Apple CarPlay/Android Auto Module Not Installed

You will get this message when selecting this option on the interface that is not equipped with Apple CarPlay/ Android Auto module.

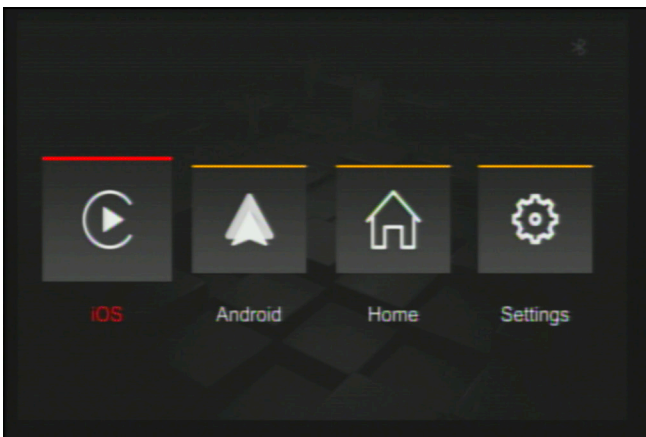

Apple CarPlay

Press enter button on joystick to enter this option.

Selecting this option will take you to your Apple CarPlay screen.

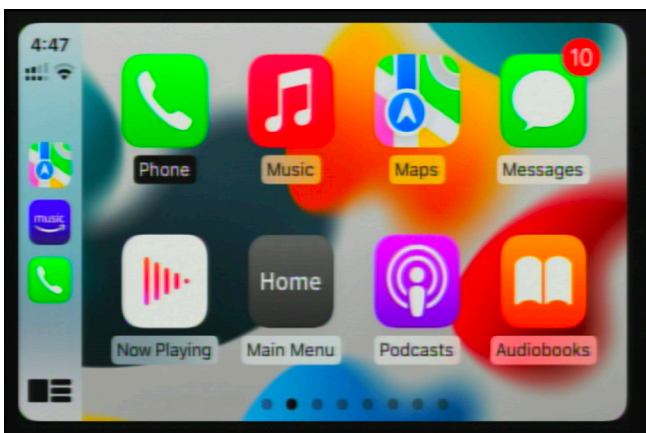

Apple CarPlay Screen

Example of Apple CarPlay screen.

Apple CarPlay is controlled via factory joystick. Selections are done by rotating joystick left or right, enter button to select. Menu button to go back.

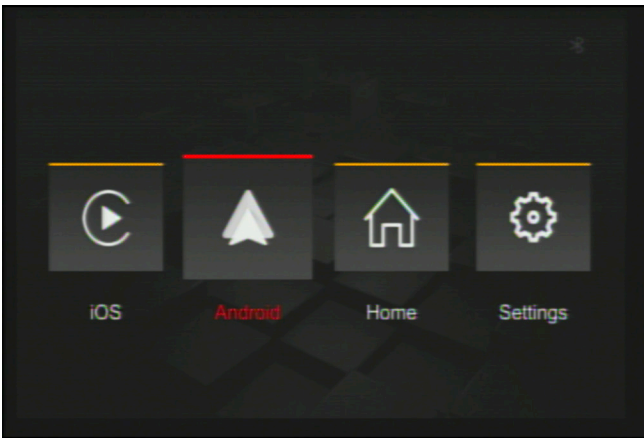

Android Auto

Press enter button on joystick to enter this option.

Selecting this option will take you to your Android Auto screen.

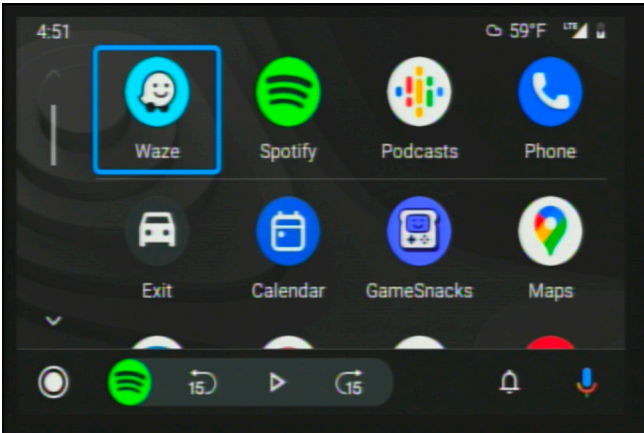

Android Auto Screen

Example of Android Auto screen.

Android Auto is controlled via factory joystick. Selections are done by rotating joystick left or right, pressing the joystick up and down to enter the bottom menu on Android Auto, enter button to select. Menu button to go back.

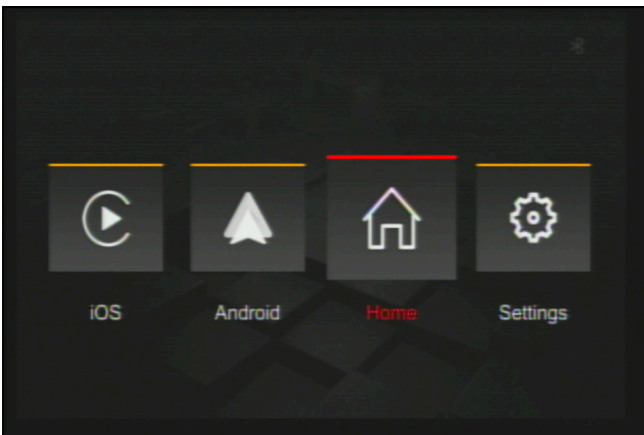

Home

Press enter button on the joystick to exit back to the main menu.

Selecting this option will take you back to the interface menu.

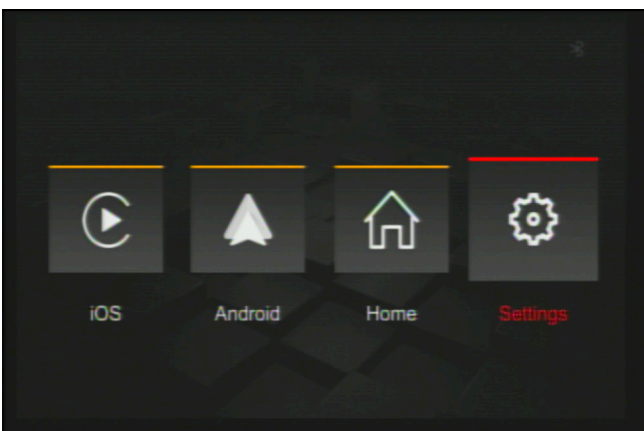

Settings

Press enter button on joystick to enter this option.

Selecting this option will allow you to change your Apple CarPlay and Android Auto settings.

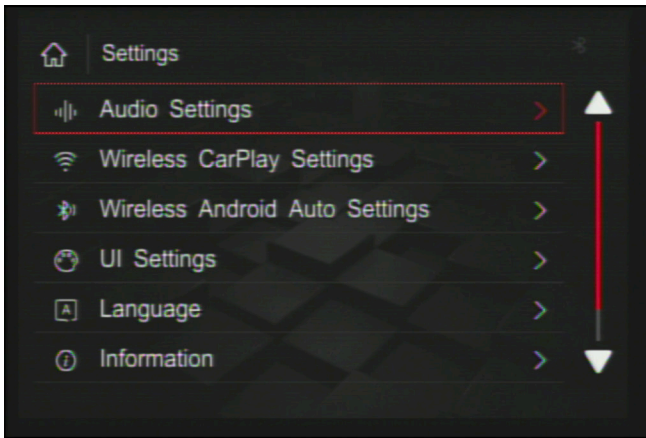

Audio Settings

Press enter button on joystick to enter this option.

Selecting this option will let you change your audio settings.

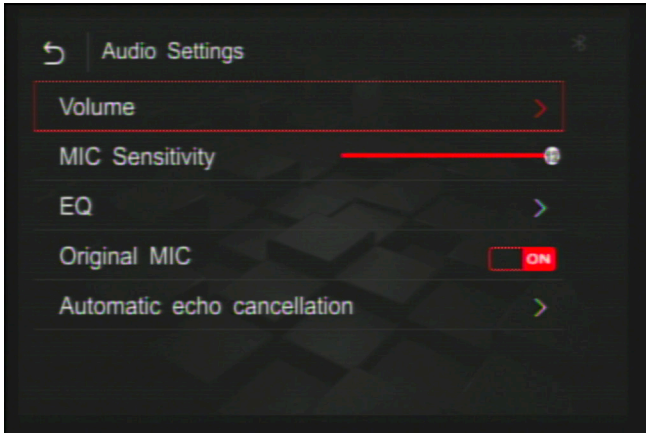

Audio Settings- Volume

Press enter button on joystick to enter this option.

Selecting this option will let you change different volume settings.

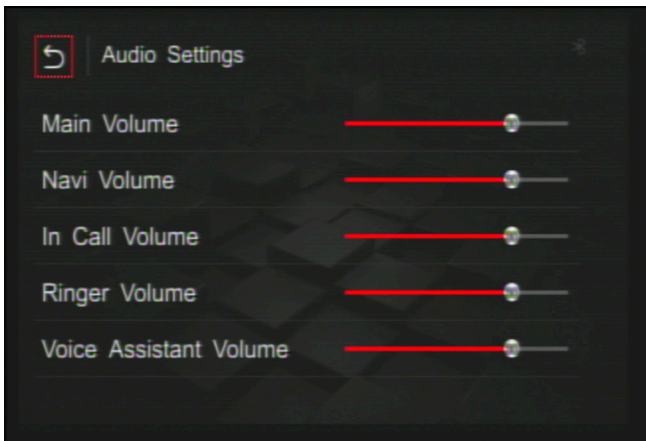

Volume

Select option by rotating joystick to a desired option, then press enter on the joystick to adjust the setting, then press enter on the joystick to save the setting.

You can change your main volume, navigation volume, call volume, ringtone volume, and voice assistant volume.

Rotate your joystick to the back button on the top left corner to go back to your audio settings.

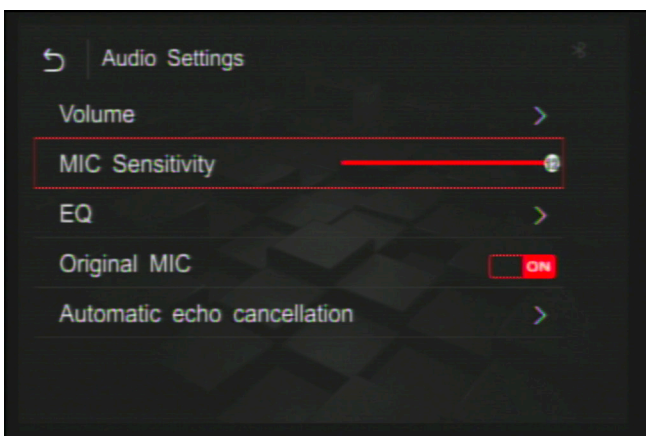

Audio Settings- MIC Sensitivity

Select option by rotating joystick to a desired option, then press enter on the joystick to adjust the setting, then press enter on the joystick to save the setting.

You can change the sensitivity of the microphone to make it more or less sensitive. Make a test call and ask the person how they hear you. If they hear too much noise, you want to make it less sensitive all the way down to 1 or 2. If they don't hear you loud enough, you can increase sensitivity to desired level.

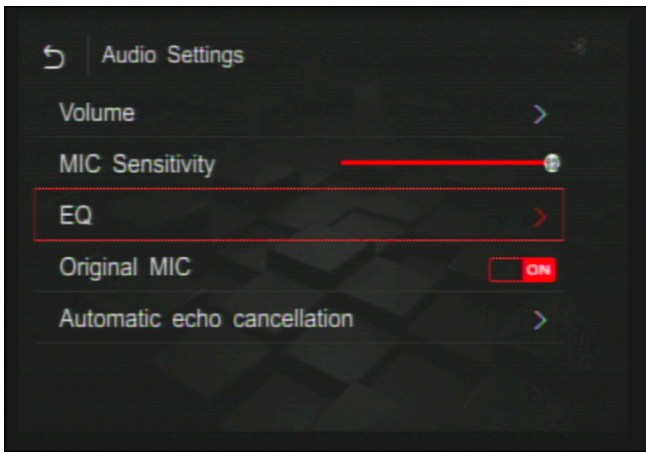

Audio Settings- EQ

Select option by rotating joystick to a desired option, then press enter on the joystick to adjust the setting.

Selecting this option will let you adjust how the audio output sounds.

Press enter button on joystick to enter this option.

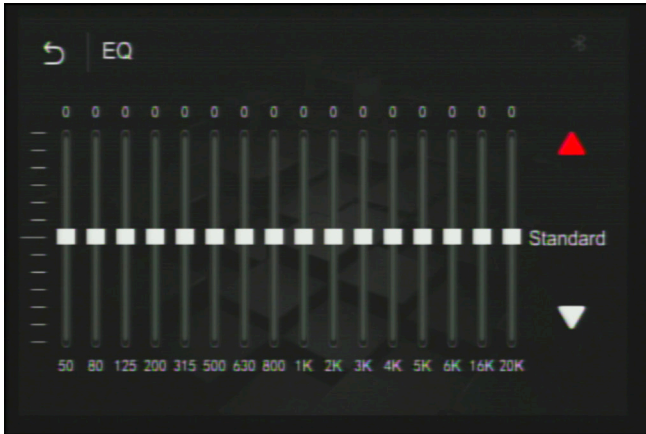

EQ

Select option by rotating joystick to a desired option, then press enter on the joystick to adjust the setting, then press enter on the joystick to save the setting.

You can select different categories for how you want your audio to sound or manually adjust it to your liking.

Rotate your joystick to the back button on the top left corner to go back to your audio settings.

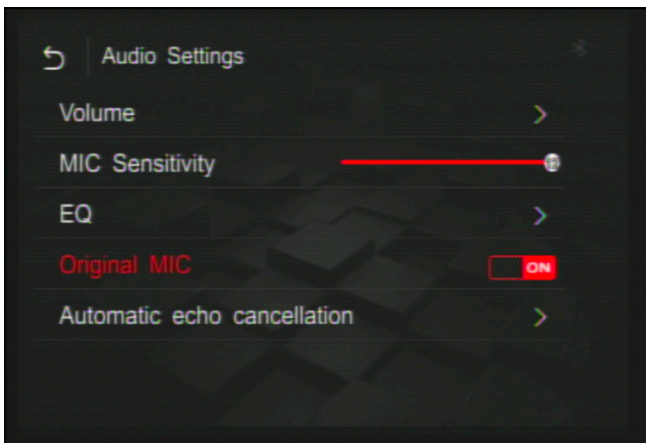

Audio Settings- Original MIC ON

Select option by rotating joystick to a desired option, then press enter on the joystick to adjust the setting, then press enter on the joystick to save the setting.

Only set this setting to ON if your vehicle is equipped with a compatible factory microphone and your interface was not equipped with an external microphone.

Press enter button on joystick to change this option.

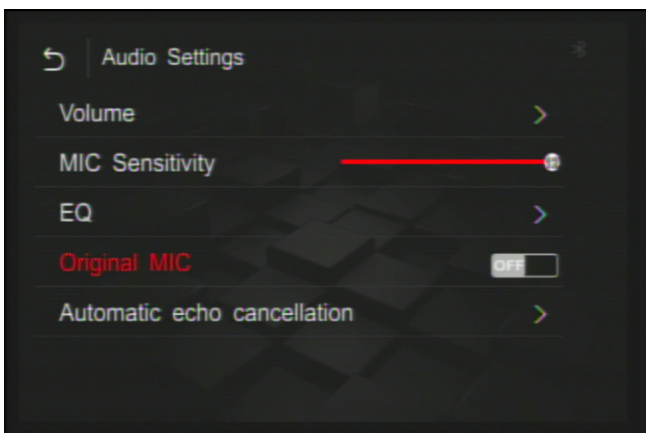

Audio Settings- Original MIC OFF

Select option by rotating joystick to a desired option, then press enter on the joystick to adjust the setting, then press enter on the joystick to save the setting.

This setting must be set to OFF if you received an external microphone with your interface, your vehicle is not equipped with a compatible factory microphone.

Press enter on the joystick to save this option.

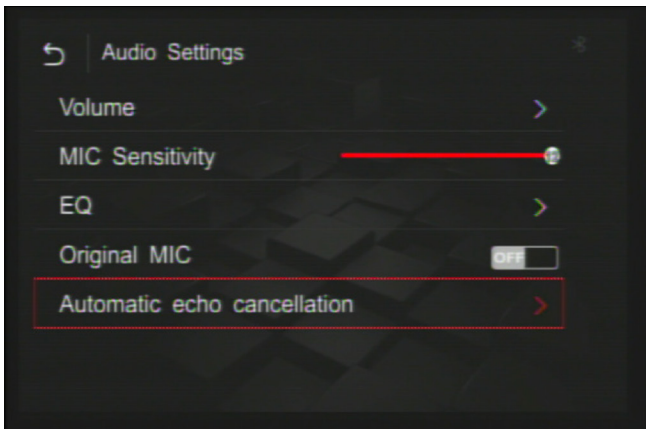

Audio Settings- Automatic Echo Cancellation

Enter this setting to adjust echo cancellation

Rotate your joystick to the back button on the top left corner to go back to your interface settings.

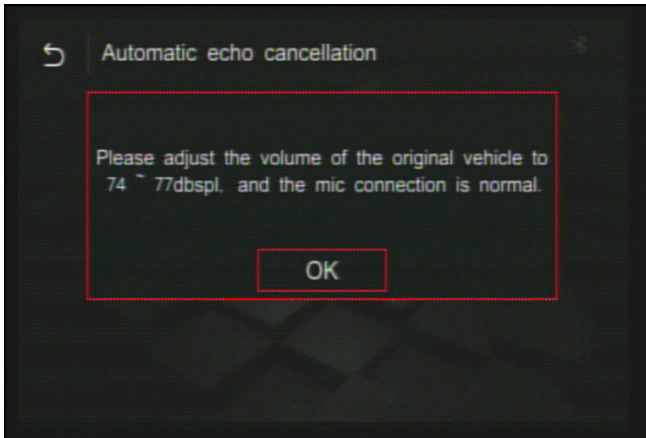

Automatic Echo Cancellation

Follow the prompt on the screen if you need to know how to set the vehicle to 74 ~ 77 db, you can find an app on the app store that measures db levels.

Rotate your joystick to the back button on the top left corner to go back to your audio settings.

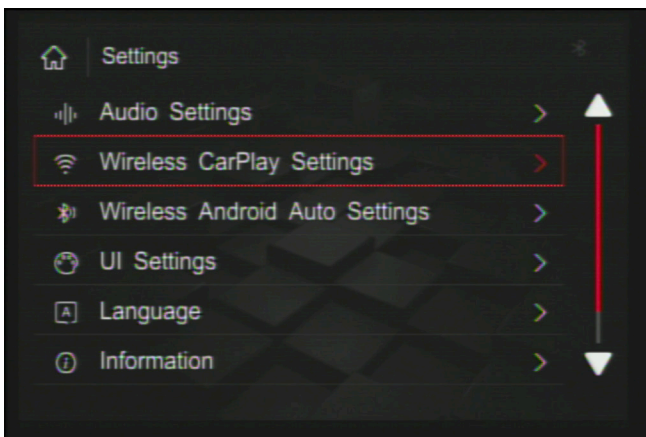

Wireless CarPlay Settings

Rotate joystick to select wireless CarPlay Settings then press enter on the joystick to enter the option.

Selecting this option will let you change your Apple CarPlay settings.

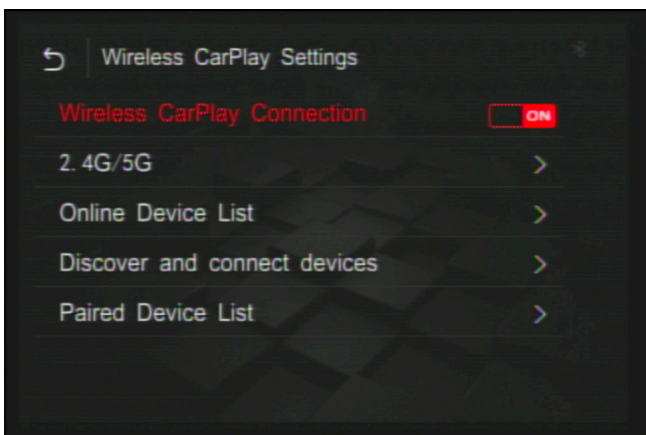

Wireless CarPlay Connection

Select option by rotating joystick to a desired option, then press enter on the joystick to adjust the setting.

You can select this option to change wireless CarPlay option ON or OFF.



Wireless CarPlay Settings- 2.4G/5G

Select option by rotating joystick to a desired option, then press enter on the joystick to adjust the setting.

You can change between 2.4G and 5G wireless connection, default option is 5G.

There is no need to enter this option and change anything, the default setting will work on all phones.



Wireless CarPlay Settings- Online Device List

Select option by rotating joystick to a desired option, then press enter on the joystick to adjust the setting.

In this option, you can see currently paired devices.

There is no need to enter this option unless you need to delete a phone in the future.

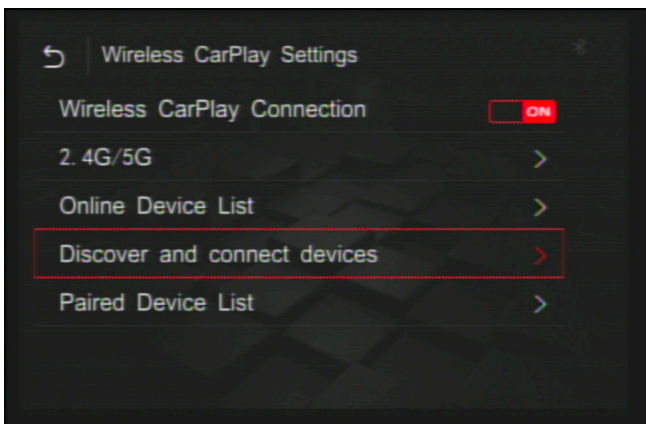

Wireless CarPlay Settings- Discover and Connect Devices

Select option by rotating joystick to a desired option, then press enter on the joystick to adjust the setting.

This option lets you connect your iPhone wirelessly for wireless Apple CarPlay option.

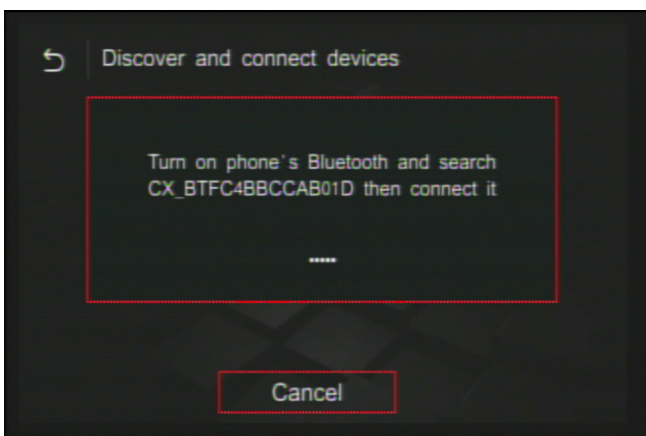

Discover and Connect Devices

After selecting Discover and Connect Devices, you will have a Bluetooth connection available for your phone to connect to and pair to the interface.

Rotate your joystick to the back button on the top left corner to go back to your Apple CarPlay settings.

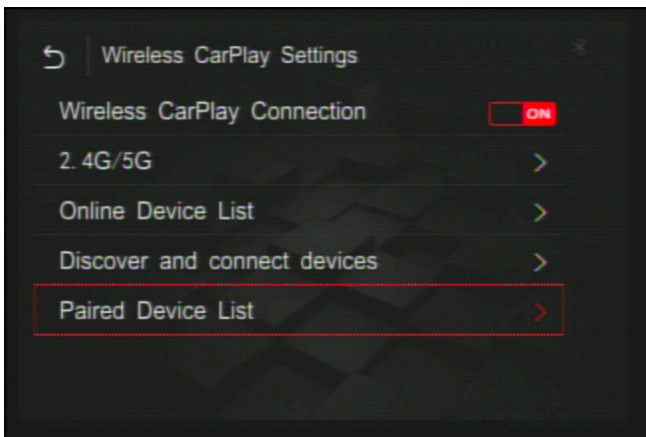

Wireless CarPlay Settings- Paired Device List

Select option by rotating joystick to a desired option, then press enter on the joystick to adjust the setting.

In this option, you can see all paired devices.

There is no need to enter this option unless you need to delete a phone in the future.

Rotate your joystick to the back button on the top left corner to go back to your interface settings.

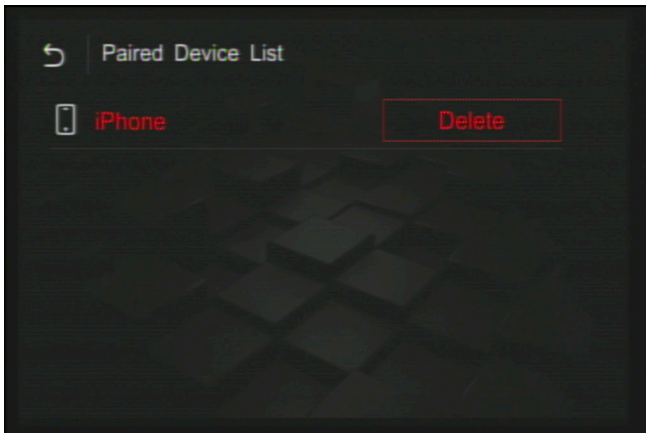

Paired Device List

Select option by rotating joystick to a desired option, then press enter on the joystick to adjust the setting.

Select delete for the device you wish to delete from the paired device list.

There is no need to enter this option unless you need to delete a phone in the future.

Rotate your joystick to the back button on the top left corner to go back to your Apple CarPlay settings.

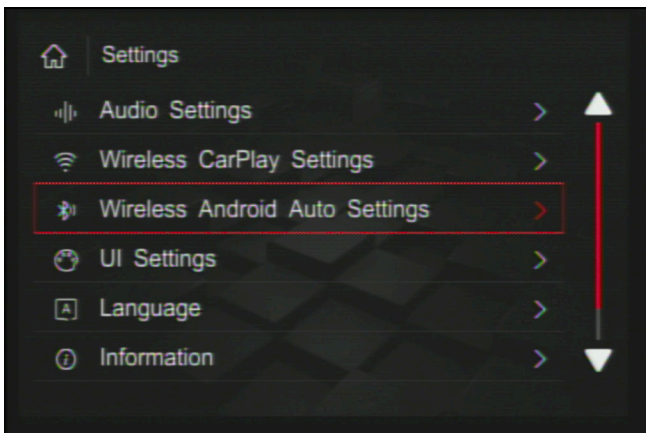

Wireless Android Auto Settings

Select option by rotating joystick to a desired option, then press enter on the joystick to adjust the setting.

Selecting this option will let you change your Android Auto settings.

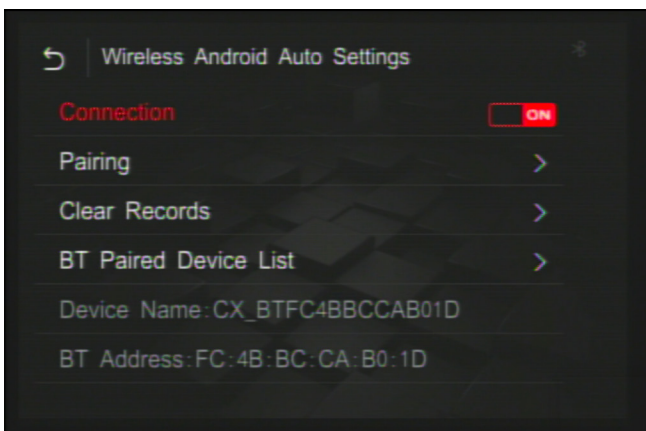

Wireless Android Auto Settings- Connection

Select option by rotating joystick to a desired option, then press enter on the joystick to adjust the setting.

You can select this option to change wireless Android Auto option ON or OFF.

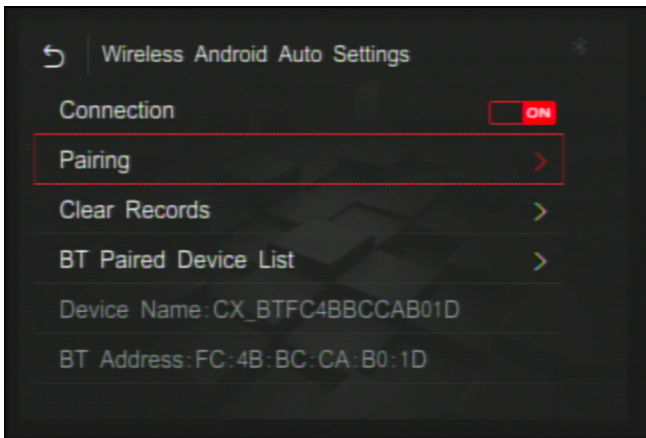

Wireless Android Auto Settings- Pairing

Select option by rotating joystick to a desired option, then press enter on the joystick to adjust the setting.

This option lets you connect your android wirelessly for wireless Android Auto option.

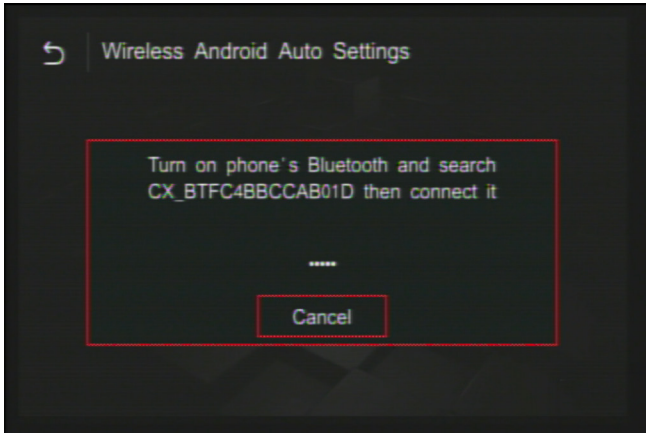

Pairing

After selecting Pairing, you will have a Bluetooth connection available for your phone to connect to and pair to the interface.

Rotate your joystick to the back button on the top left corner to go back to your Android Auto settings.



Wireless Android Auto Settings- Clear Records

Select option by rotating joystick to a desired option, then press enter on the joystick to adjust the setting.

In this option, you can see all paired devices.

There is no need to enter this option unless you need to delete a phone in the future.

Rotate your joystick to the back button on the top left corner to go back to your interface settings.

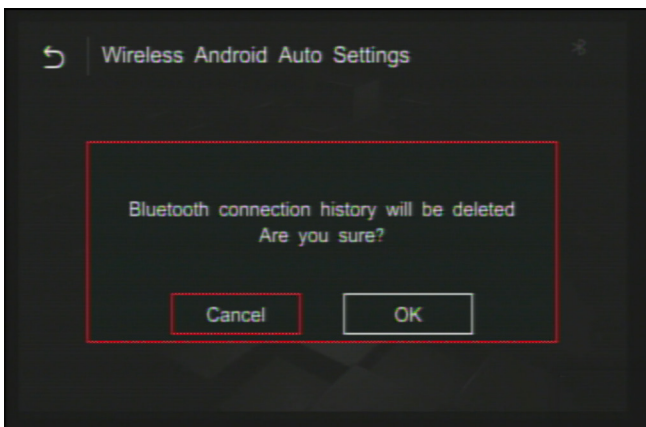

Clear Records

Select option by rotating joystick to a desired option, then press enter on the joystick to adjust the setting.

Select delete for the device you wish to delete from the paired device list.

There is no need to enter this option unless you need to delete a phone in the future.

Rotate your joystick to the back button on the top left corner to go back to your Android Auto settings.

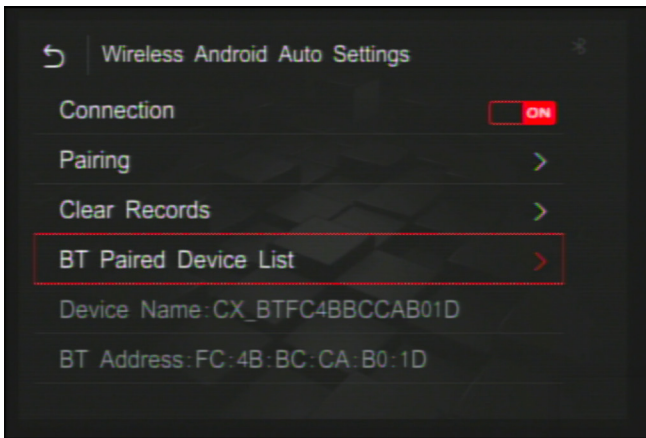

Wireless Android Auto Settings- BT Paired Device List

Select option by rotating joystick to a desired option, then press enter on the joystick to adjust the setting.

In this option, you can see currently paired devices.

There is no need to enter this option unless you need to delete a phone in the future.

Rotate your joystick to the back button on the top left corner to go back to your interface settings.

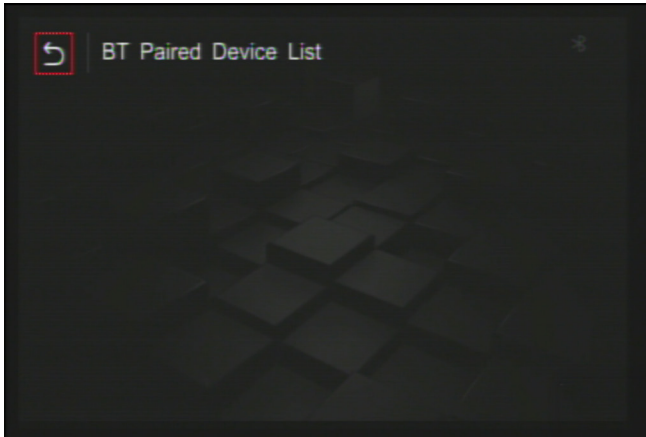

Bluetooth Paired Device List

Select option by rotating joystick to a desired option, then press enter on the joystick to adjust the setting.

Select delete for the device you wish to delete from the paired device list.

There is no need to enter this option unless you need to delete a phone in the future.

Rotate your joystick to the back button on the top left corner to go back to your Android Auto settings.

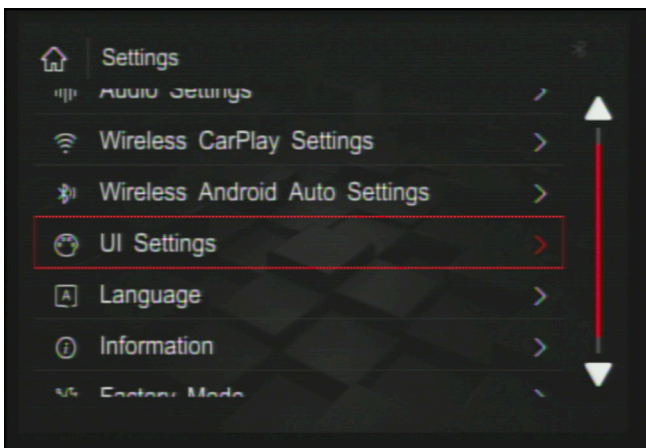

UI Settings

Select option by rotating joystick to a desired option, then press enter on the joystick to adjust the setting.

Selecting this will allow you to change your UI settings of the interface.

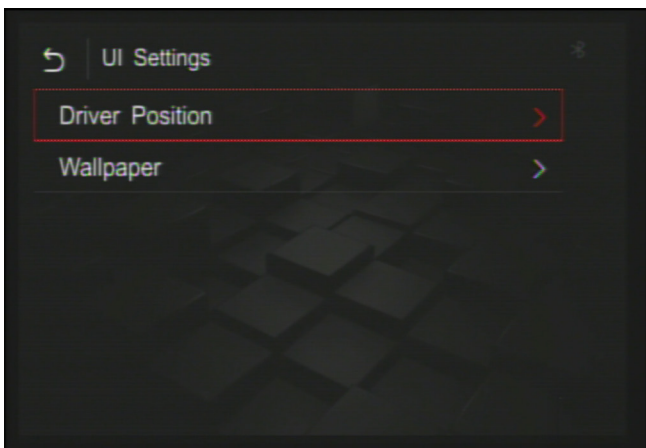

UI Settings- Driver Position

Select option by rotating joystick to a desired option, then press enter on the joystick to adjust the setting.

You can select or change which driver position you are in.



Driver Position

Select option by rotating joystick to a desired option, then press enter on the joystick to adjust the setting.

You can select which side the driver position is on your car, either left or right. Also you can move the menu position of Apple CarPlay/ Android Auto on left or right in case something is blocking the menu.

Rotate your joystick to the back button on the top left corner to go back to your UI settings.

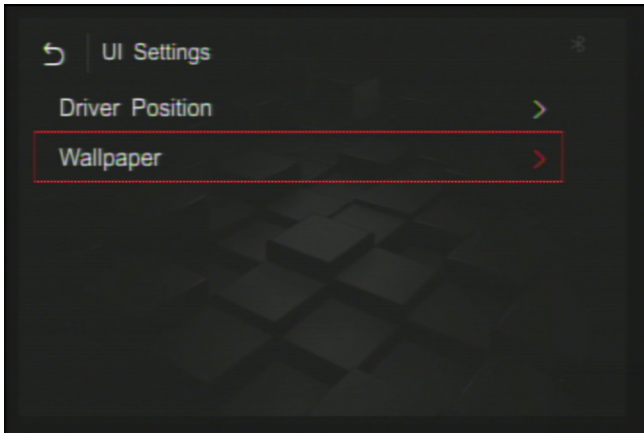

UI Settings- Wallpaper

Select option by rotating joystick to a desired option, then press enter on the joystick to adjust the setting.

After selecting this, you can change what wallpaper you want to have displayed on the interface.

Rotate your joystick to the back button on the top left corner to go back to your interface settings.

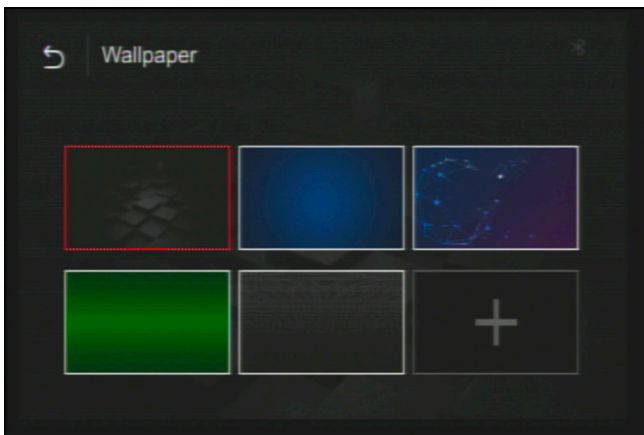

Wallpaper

Select option by rotating joystick to a desired option, then press enter on the joystick to adjust the setting.

You can select which wallpaper you want to have displayed on the interface.

Rotate your joystick to the back button on the top left corner to go back to your UI settings.

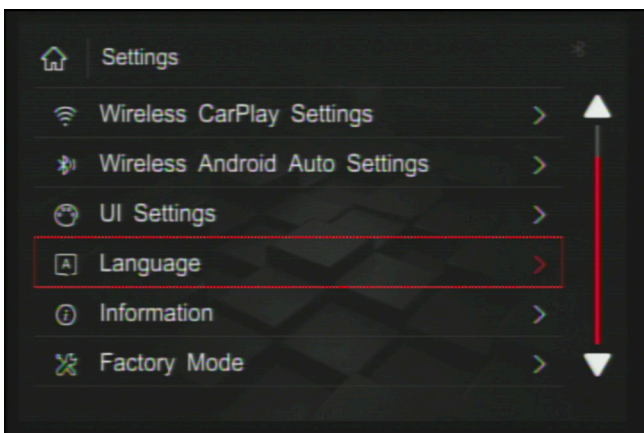

Language

Select option by rotating joystick to a desired option, then press enter on the joystick to adjust the setting.

You can select this to change the language of the interface.

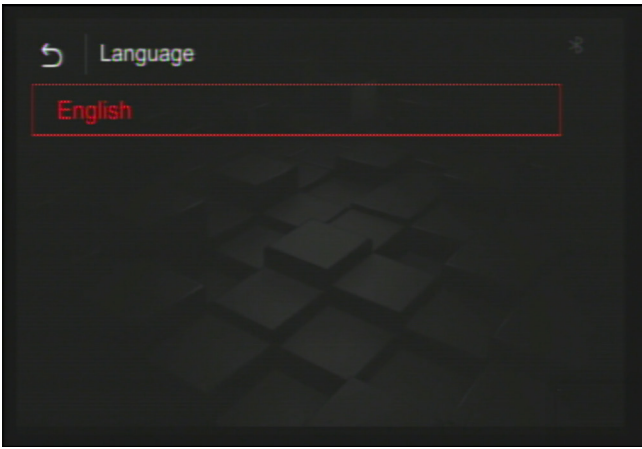

Language

Select option by rotating joystick to a desired option, then press enter on the joystick to adjust the setting.

Selection screen for the language setting.

Rotate your joystick to the back button on the top left corner to go back to your language settings.

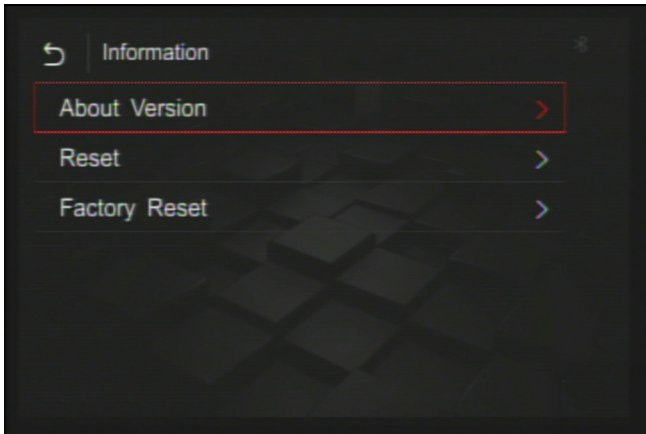

Information

Select option by rotating joystick to a desired option, then press enter on the joystick to adjust the setting.

After selecting information, you can find more information about the interface version, and the ability to reset or factory reset.

Rotate your joystick to the back button on the top left corner to go back to your interface settings.

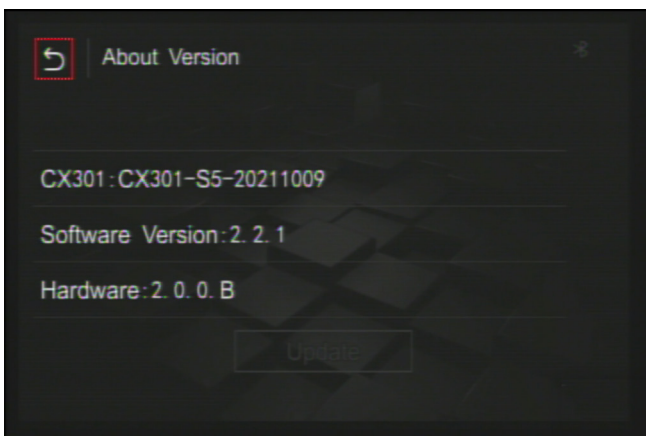

About Version

Select option by rotating joystick to a desired option, then press enter on the joystick to adjust the setting.

After selecting information, you can find more information about the interface version, and the ability to reset or factory reset.

Rotate your joystick to the back button on the top left corner to go back to your information settings.



Reset

Select option by rotating joystick to a desired option, then press enter on the joystick to adjust the setting.

Selecting this will let you reset your interface options.

Rotate your joystick to the back button on the top left corner to go back to your information settings.

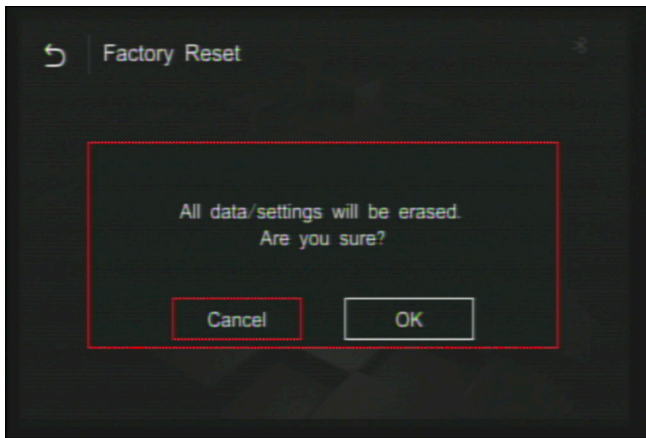

Reset

Select option by rotating joystick to a desired option, then press enter on the joystick to adjust the setting.

Selecting this will reset the interface unit and the options you have changed.

Rotate your joystick to the back button on the top left corner to go back to your information settings.

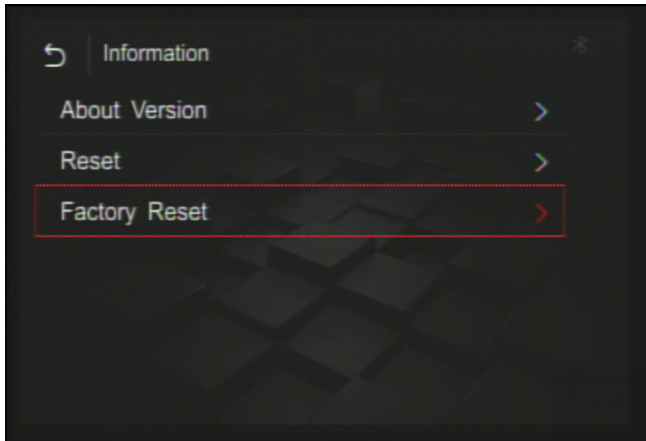

Information- Factory Reset

Select option by rotating joystick to a desired option, then press enter on the joystick to adjust the setting.

Selecting this will allow you to factory reset your interface.

Rotate your joystick to the back button on the top left corner to go back to your interface settings.

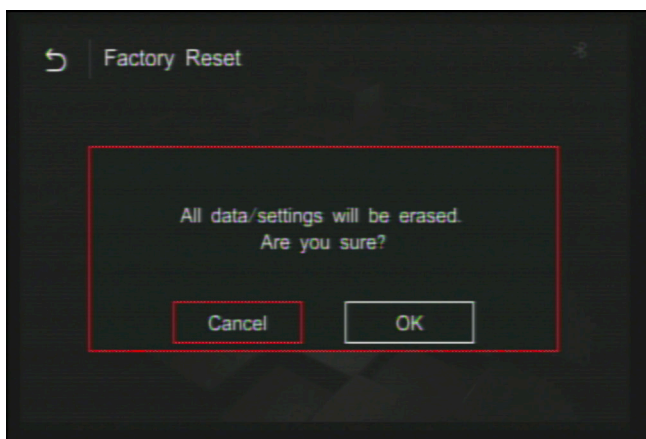

Factory Reset

Select option by rotating joystick to a desired option, then press enter on the joystick to adjust the setting.

Factory resetting your interface will erase all data and settings that were previously on it.

Rotate your joystick to the back button on the top left corner to go back to your information settings.

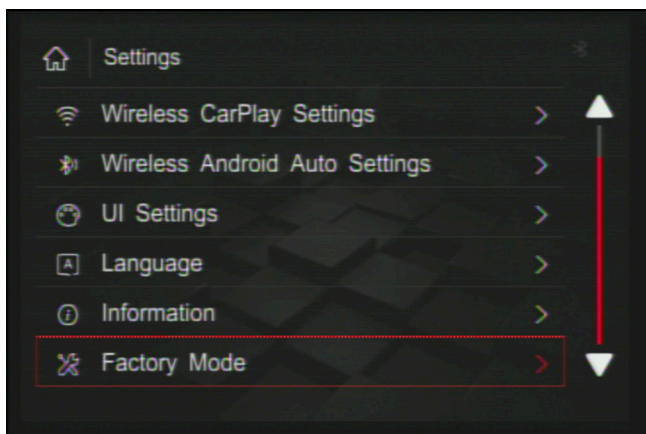

Factory Mode

Do not enter this mode as it is password protected and changing any features will break the interface.

Press and hold the menu button until you see the bottom menu.

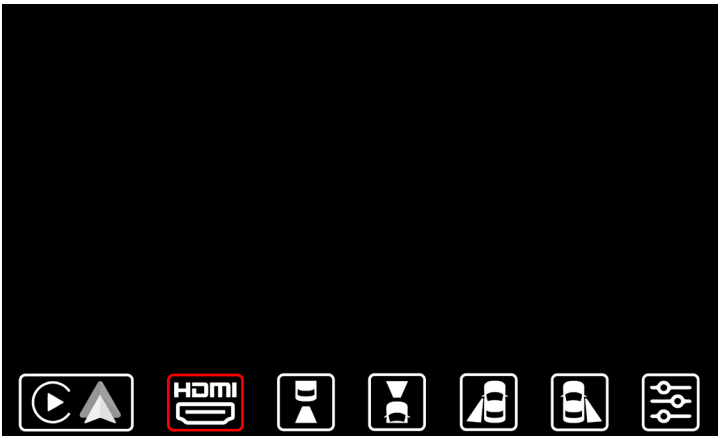

HDMI

Rotate joystick to select HDMI option then press enter button on joystick to enter this option.

After selecting HDMI with a HDMI source attached, you will be brought to your HDMI's device screen and connected image will appear on the screen.

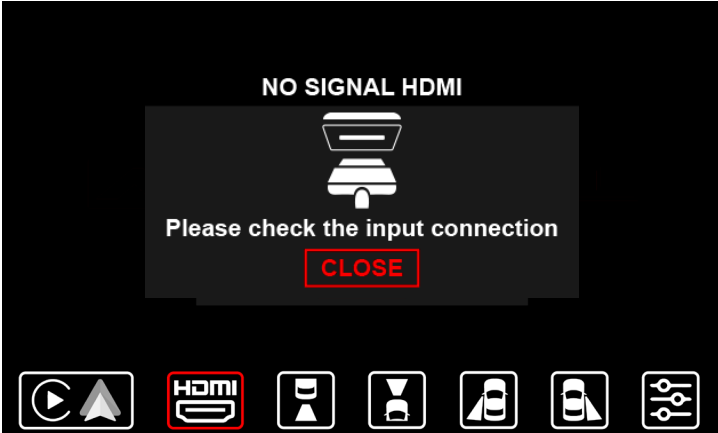

No HDMI Signal

You will get this message when selecting this input with no HDMI source connected to interface.

This part of the page has been intentionally left blank



Back-Up Camera

Rotate joystick to select Back-Up Camera option then press enter button on joystick to enter this option.

After selecting the back-up camera input, you will be brought to your back up camera screen. This will not work if a back-up camera is not installed. (Note: This input will not display factory installed rear-view camera)



Front Camera

Rotate joystick to select Front Camera option then press enter button on joystick to enter this option.

After selecting the front camera input, you will be brought to your front camera screen. This will not work if a front camera is not installed. (Note: This input will not display factory installed forward facing camera)



Left Lane Watch Camera

Rotate joystick to select Left Lane Watch Camera option then press enter button on joystick to enter this option.

After selecting the left lane watch camera input, you will be brought to your left lane watch camera screen. This will not work if a left lane watch camera is not installed. (Note: This input will not display factory installed left lane watch camera)

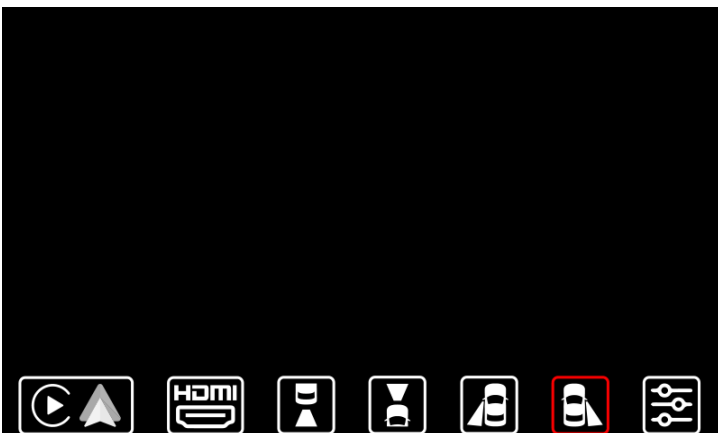

Right Lane Watch Camera

Rotate joystick to select Right Lane Watch Camera option then press enter button on joystick to enter this option.

After selecting the right lane watch camera input, you will be brought to your right lane watch camera screen. This will not work if a right lane watch camera is not installed. (Note: This input will not display factory installed right lane watch camera)



Settings

Rotate joystick to select the settings option then press enter button on joystick to enter this option.

After selecting the settings option, a menu will expand showing different interface settings you can change.



Settings Options Menu

Rotate joystick to select the settings option then press enter button on joystick to enter this option.

Selecting the setting options input, you will have access to change brightness, contrast, camera settings, parking line settings, and interface settings. You can close this by selecting the down arrow.



Brightness

Rotate joystick to select the brightness option then press enter button on joystick to enter this option.

After selecting brightness, you can adjust the brightness of the interface. The white bar in the middle shows what the interface brightness is set at. You can lower the brightness of the interface by selecting the icon on the left and you can increase the brightness of the interface by selecting the icon on the right. Save or cancel any changes you have made.

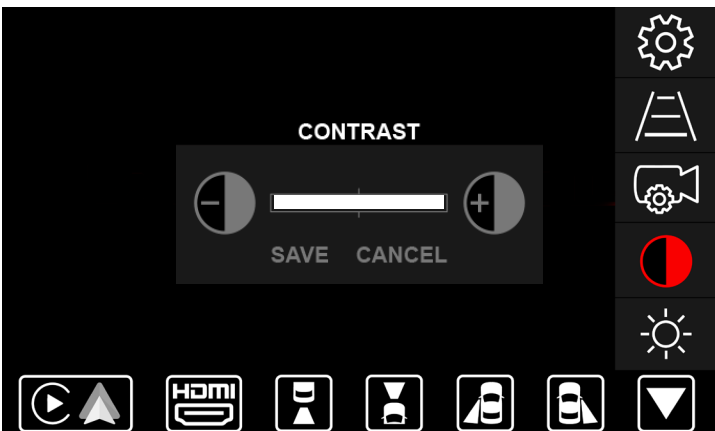

Contrast

Rotate joystick to select the contrast option then press enter button on joystick to enter this option.

After selecting contrast, you can adjust the interface's contrast. The white bar in the middle shows what the interface contrast is set at. You can lower the contrast of the interface by selecting the icon on the left and you can increase the contrast of the interface by selecting the icon on the right. Save or cancel any changes you have made.



Camera Settings

Rotate joystick to select the Camera Settings then press enter button on joystick to enter this option.

Camera Settings Menu

Rotate the joystick to select a particular camera input. Then press enter on the joystick to select an option you want for that particular camera input.

Factory camera: Select this option if your vehicle is equipped with a factory installed rear view camera.

Video input: Select this option if your vehicle is not equipped with a factory rear view camera and you are not planning to add a aftermarket camera or if you wish to use this input as a video input.

Aftermarket camera: Select this option if you are installing an aftermarket rear view camera.

Parking lines: Select this option if you are installing an aftermarket rear view camera and you wish to add distance lines to the camera image.

Factory camera: Select this option if your vehicle is equipped with a factory installed forward facing camera. Do not select this option if your vehicle is equipped with 360 degree parking cameras, 360 degree front parking camera is not considered forward facing camera.

Video input: Select this option if your vehicle is not equipped with a factory forward facing camera and you are not planning to add a aftermarket camera or if you wish to use this input as a video input.

Aftermarket camera: Select this option if you are installing an aftermarket forward facing camera.

Parking lines: Select this option if you are installing an aftermarket forward facing camera and you wish to add distance lines to the camera image.

INPUTS	FACTORY CAMERA	VIDEO INPUT	AFTERMARKET CAMERA	PARKING LINES
	<input type="radio"/>	<input type="radio"/>	<input type="radio"/>	<input type="radio"/>
	<input type="radio"/>	<input type="radio"/>	<input type="radio"/>	<input type="radio"/>
	<input type="radio"/>	<input type="radio"/>	<input type="radio"/>	<input type="radio"/>
	<input type="radio"/>	<input type="radio"/>	<input type="radio"/>	<input type="radio"/>
				SAVE CANCEL

Factory camera: Select this option if your vehicle is equipped with a factory installed right lane watch camera. Do not select this option if your vehicle is equipped with 360 degree parking cameras, 360 degree right parking camera is not considered forward facing camera.

Video input: Select this option if your vehicle is not equipped with a factory right lane watch camera and you are not planning to add a aftermarket camera or if you wish to use this input as a video input.

Aftermarket camera: Select this option if you are installing an aftermarket right lane watch camera.

Parking lines: Select this option if you are installing an aftermarket right lane watch camera and you wish to add distance lines to the camera image.

Factory camera: Select this option if your vehicle is equipped with a factory installed left lane watch camera. Do not select this option if your vehicle is equipped with 360 degree parking cameras, 360 degree front parking camera is not considered forward facing camera.

Video input: Select this option if your vehicle is not equipped with a factory left lane watch camera and you are not planning to add a aftermarket camera or if you wish to use this input as a video input.

Aftermarket camera: Select this option if you are installing an aftermarket left lane watch camera.

Parking lines: Select this option if you are installing an aftermarket left lane watch camera and you wish to add distance lines to the camera image.





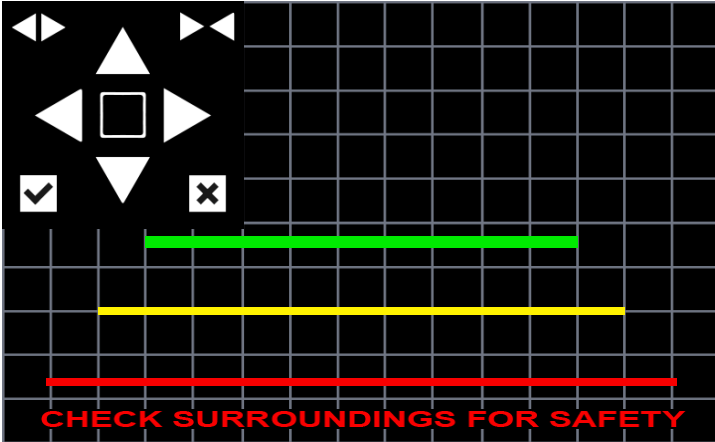

Parking Line Settings

How to navigate the interface to change parking line settings. You can only access this setting when you are on the particular camera input. Select the camera input prior to going into parking line settings.



Parking Line Settings

After selecting parking line settings, you can adjust the parking lines of the interface. Your interface will display which camera input you chose with grid lines instead of a black background. You can choose which parking line you want to make changes to by selecting the square in the middle. The white circle in the square indicates which parking line you are making changes to.

-  Green Parking Line
-  Yellow Parking Line
-  Red Parking Line
-  Green Parking Line Selected
-  Yellow Parking Line Selected
-  Red Parking Line Selected

Increase Line Width

You can increase your parking line width to a desired size.

Up
You can move your parking lines up by selecting the up arrow for your selected parking line.

Decrease Line Width

You can decrease your parking line width to a desired size.

Left

You can move your parking lines left by selecting the left arrow for your selected parking line.

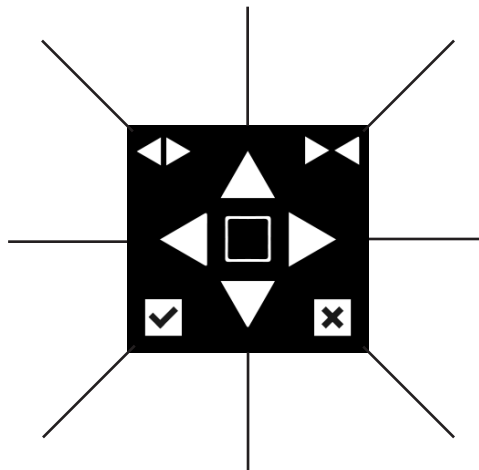

Right

You can move your parking lines right by selecting the right arrow for your selected parking line.

Save

After making changes to your parking line settings, select the check to save your changes.

Down

You can move your parking lines down by selecting the down arrow for your selected parking line.

Cancel

After making changes to your parking line settings, select the X to cancel your changes.



Interface Settings

Rotate joystick to select the Interface Settings option then press enter button on joystick to enter this option.

How to navigate the interface to change your interface settings. After selecting interface settings, you can adjust miscellaneous settings of the interface. Save or cancel any interface changes.

Set this feature to ON if you want to enter Apple CarPlay/Android Auto mode when activating the interface, and bypassing the interface menu.

Set this feature to OFF if you want to enter Interface menu upon activation of the interface.

MISCELLANEOUS SETTINGS	ON	OFF
APPLE CARPLAY / ANDROID AUTO (AUTO ON MODE)	<input type="radio"/>	<input type="radio"/>
INTERFACE CHIRP SOUND	<input type="radio"/>	<input type="radio"/>
MANUAL ACTIVATION WIRE AS REVERSE TRIGGER +12V	<input type="radio"/>	<input type="radio"/>
	SAVE	CANCEL

Turn this feature to ON to enable audio feedback from the interface when activating the interface or when smartphone wireless connection is established.

Turn this feature to OFF if audio feedback from the interface is not required.

Turn ON manual activation wire as reverse trigger if your manual tells you to or if done by an installer. Do not change if they have set this to on.

Turn OFF: Most vehicles will have manual activation wire turned off. Do not change unless your manual tells you or if done by an installer.

User Manual

**Disconnect your phone from the vehicle's factory Bluetooth if connected.
Go to the Bluetooth Settings of your phone and select (Forget this Device) for the vehicle.**

You will be connecting to the Apple CarPlay / Android Auto feature of the interface via Bluetooth Connection. If you do not disconnect your phone from the vehicle's factory Bluetooth, the vehicle will not know which Bluetooth Connection it should automatically pair to. This will cause connection issues for Apple CarPlay / Android Auto.

Set the vehicle's radio to AUX or an alternative AUX input device.

Interface audio will not play through the car speakers if AUX is not connected or radio is not set to AUX input. This includes audio from Apple CarPlay, Android Auto, HDMI, navigation directions, music, and phone calls.

Press and hold the back button on the supplied remote for 3-5 seconds to turn on and off the interface.

If the interface is not displaying on the screen, please check that the remote control buttons light up when pressing any buttons. If it does not light up, twist open the lid of the remote. Open the battery door and insert or replace batteries.



Back Button

Remote Operation Guide

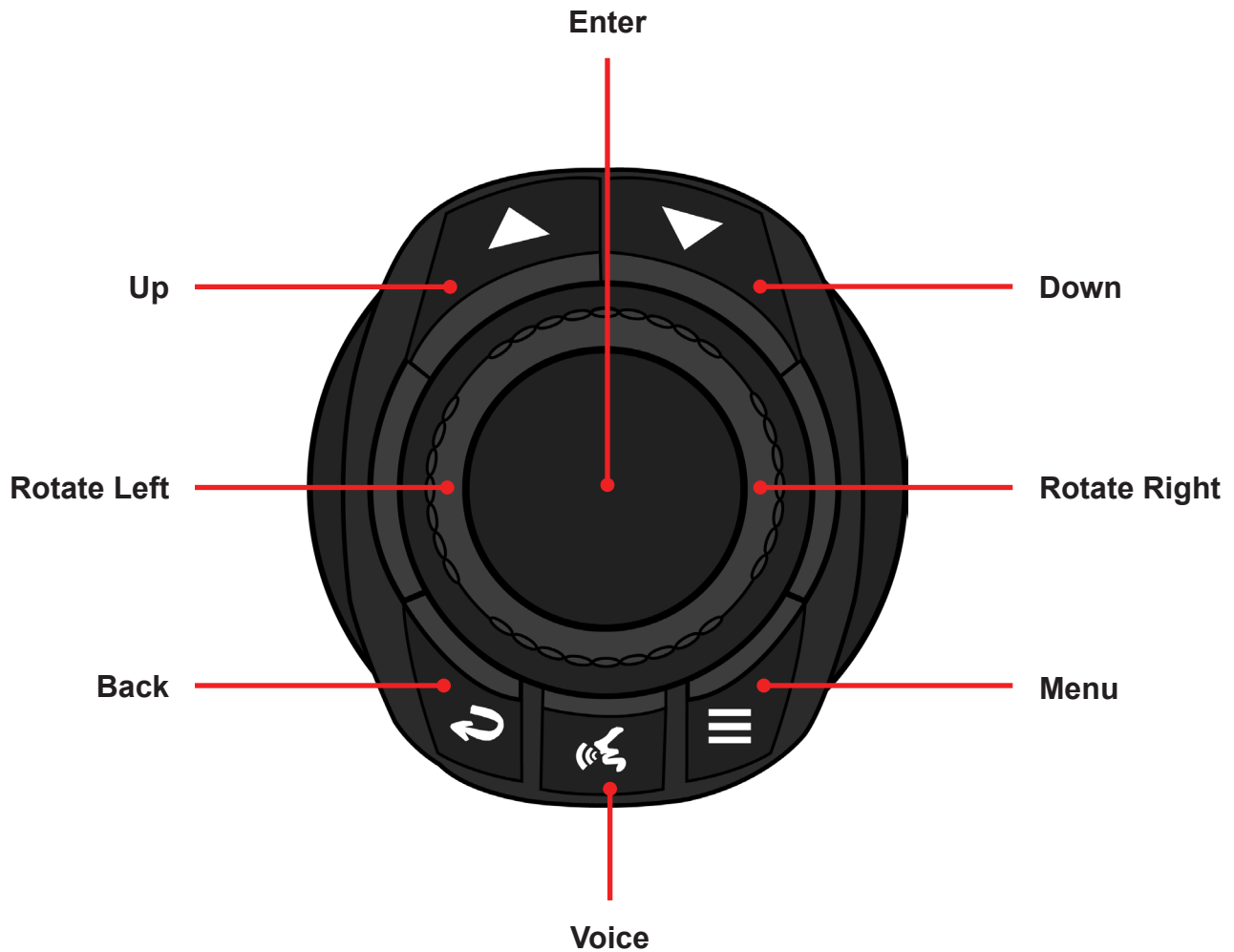

Up- Press to go UP inside of Apple CarPlay or Android Auto.

Down- Press to go DOWN inside Apple CarPlay or Android Auto.

In Android Auto, DOWN button is used to enter the bottom menu bar of Android Auto.

Rotate Left- To go LEFT inside Apple CarPlay, Android Auto, and the interface menu.

Rotate Right- To go RIGHT inside Apple CarPlay, Android Auto, and the interface menu.

Back- Press to go back inside Apple CarPlay or Android Auto.

Press and hold for 3-5 seconds to turn the interface ON or OFF.

Voice- Press to activate Siri or Ok Google.

Menu- Brings up the interface's bottom menu to change inputs or go into settings.

Enter- ENTER button

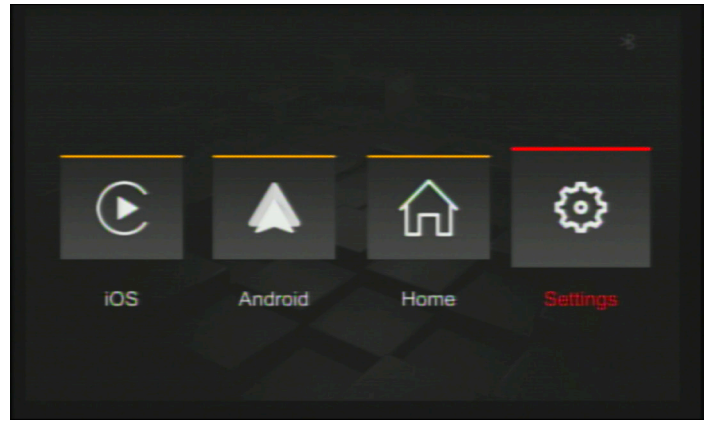

Apple CarPlay/Android Auto Settings Menu

Selecting Apple CarPlay/Android Auto will bring you to your Apple CarPlay/Android Auto screen if your phone is connected or paired. If no phone is connected or paired by Bluetooth, it will bring you to the Apple CarPlay/Android Auto Settings Menu (see right image). Select Settings to connect your phone to Apple CarPlay/Android Auto (see next page for instructions).

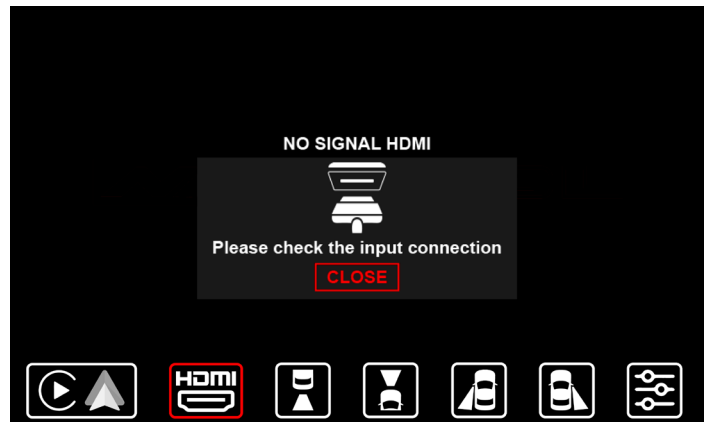
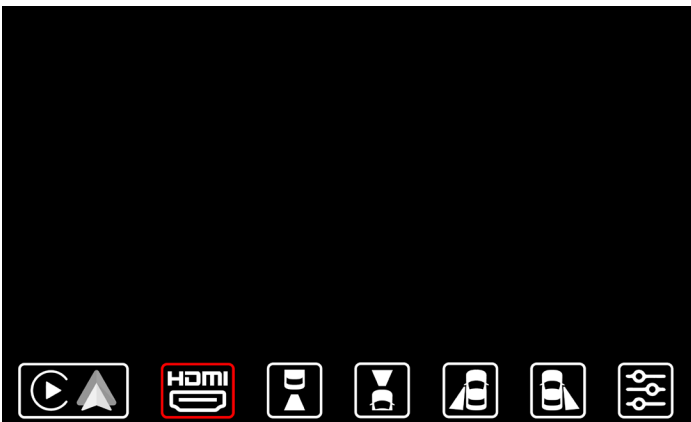

HDMI

Selecting HDMI Input will bring you to the HDMI Input of the interface. If no HDMI device is connected, you will see a No Signal HDMI message.

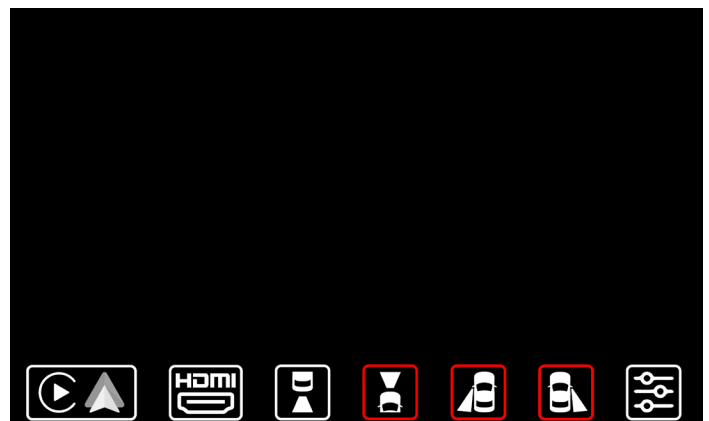
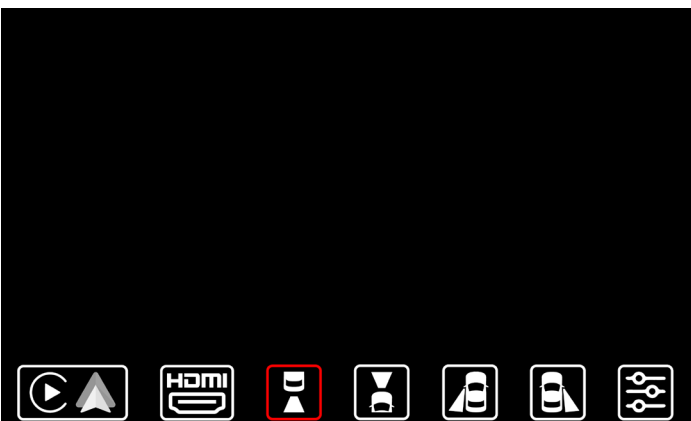

Cameras / Video Input

Selecting Camera Inputs will let you see your aftermarket cameras if installed. If your vehicle has factory cameras such as a factory rear view camera, you won't be able to manually view them from here. It will still automatically display when putting the vehicle in reverse. If the vehicle is equipped with CAN, aftermarket front camera will automatically show when in drive up to 5-10 mph, and aftermarket left and right cameras will automatically show when activating left and right turn signals.

Connecting Your Phone to Apple CarPlay / Android Auto

Disconnect your phone from the vehicle's factory Bluetooth before connecting your phone to the interface. Go to the Bluetooth settings of your phone and select **Forget This Device**.

Follow the diagram below to connect your phone. Make sure your phone's Wifi and Bluetooth are on. Connect to the Bluetooth name of the interface on the CarPlay / Bluetooth Setting of your phone.

iPhone: General > Settings > CarPlay > Connect

Android: Settings > Bluetooth > Connect

Apple CarPlay

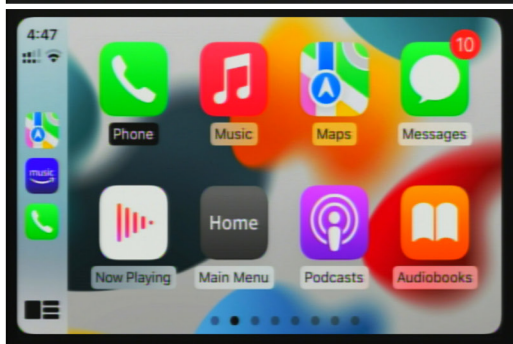
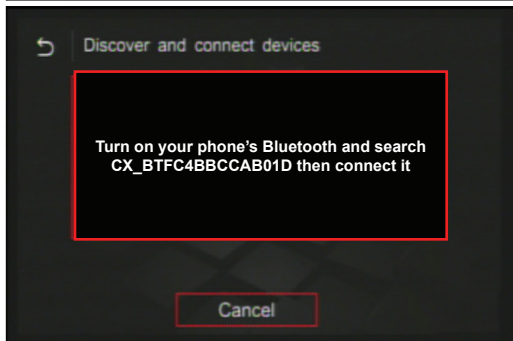
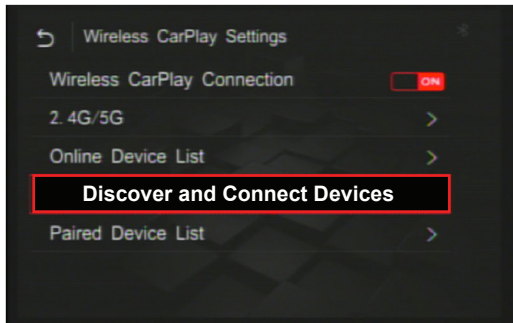
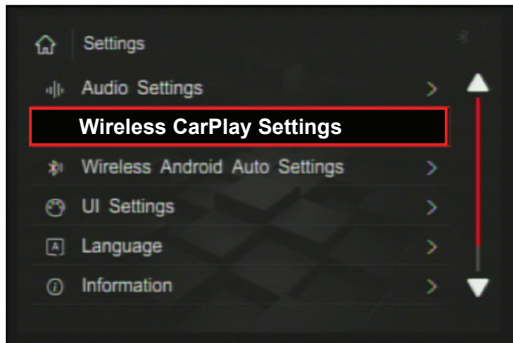

Android Auto

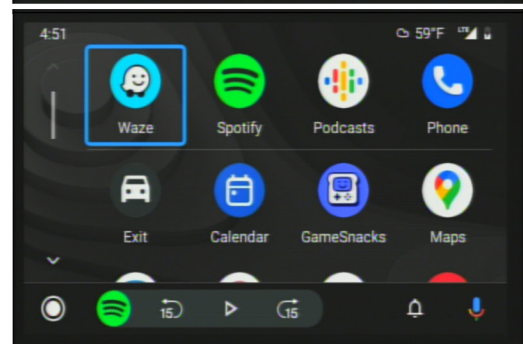
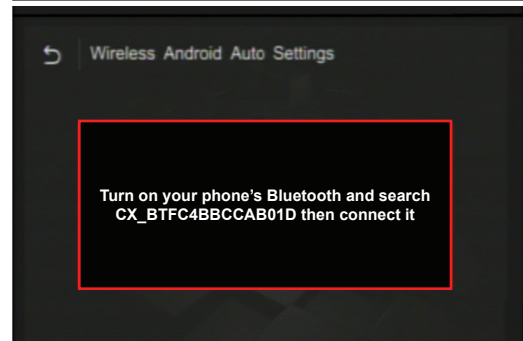
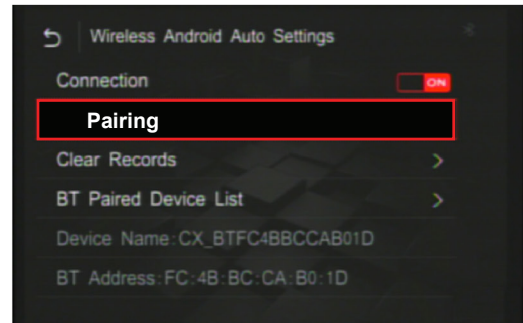
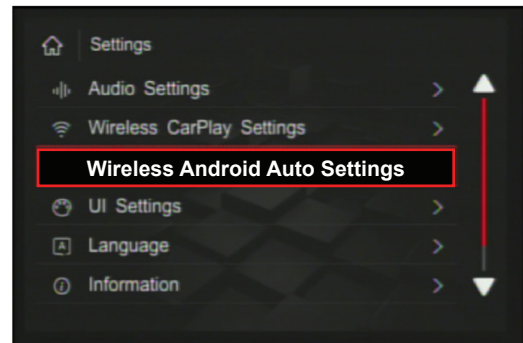

Apple CarPlay / Android Auto

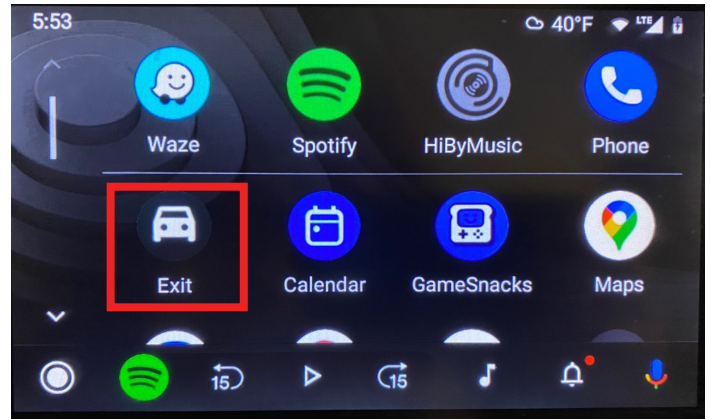
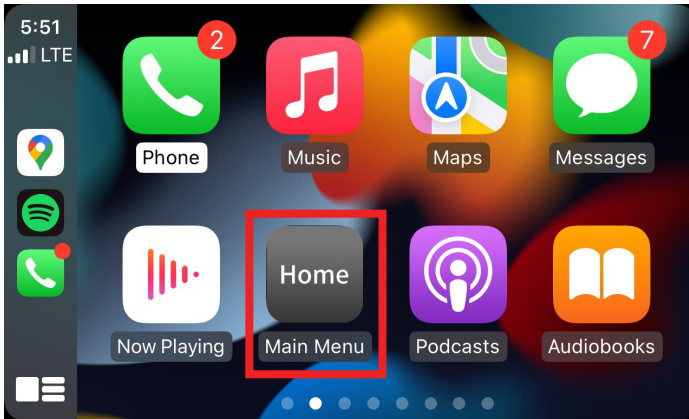

Microphone will not work if the Original MIC setting is not set correctly.
Audio will not play from the vehicle's speakers if the radio is not set to AUX.

To access the bottom interface menu bar

Press the Menu button or press and hold the Back button for 3-5 seconds on the supplied remote. This will make the bottom interface menu bar appear.

To Exit the interface and return to your vehicle's factory menu

Once you have access to the bottom interface menu bar, you can press and hold the Back button for 3-5 seconds on the supplied remote to exit the interface returning you to the vehicle's factory screen.

To Exit Apple CarPlay / Android Auto and return to your vehicle's factory menu

Apple CarPlay- Select the Main Menu App

Android Auto- Select the Exit App

You will not have access to the Apple CarPlay / Android Auto Settings Menu once paired

If you need to go back and make any changes to the Apple CarPlay / Android Auto Settings, set Apple CarPlay/Android Auto (Auto On Mode) to OFF in the Interface Miscellaneous Settings or disconnect your phone from the interface or turn off your phone's wifi and Bluetooth.

See Interface Menus and Settings section of the manual for details about different settings options.