

Installation Manual (NAVRGB6.0-VI+HONIRC1)

Honda Fit 2007-2011

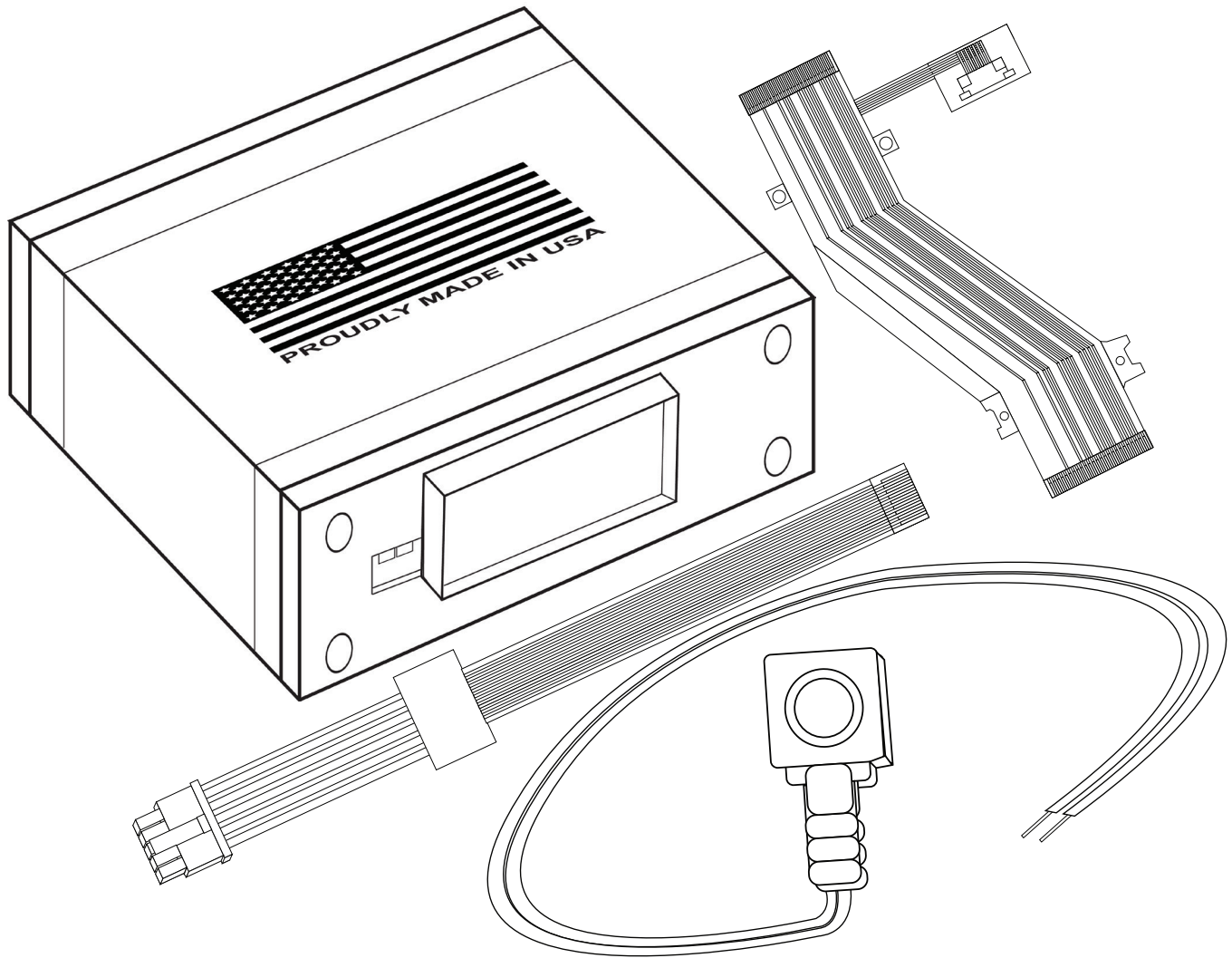

Manual Version: 1.0

DESIGNED + MANUFACTURED IN THE



NOTICE: We recommend having this installation performed by a certified technician.
All product names, logos, brands, trademarks and registered trademarks are property of their respective owners.

WELCOME

IMPORTANT WARNING

Failure to follow these instructions carefully or not installing the interface as described could cause damage to the vehicle or safety systems on the vehicle. Any interference with specific safety systems could cause harm to other people as well.

This manual provides detailed instructions for this specific interface and vehicle type. Follow them as described. If the installer is not sure or does not feel comfortable, consult a competent technician who has the knowledge, experience, and understanding of how to complete the installation. Failure to do so will void your warranty on your interface and maybe on the vehicle.

Precautions

PLEASE READ BEFORE YOU START THE INSTALLATION

- Please study these instructions carefully before installing the interface.
- Protect the areas of the vehicle you will be working on before starting the disassembly.
- Use painters' tape or equivalent, and use protective blankets or covers on the front seats, interior panels, and center console.
- Do not disconnect the battery if the vehicle has an anti-theft coded radio unless you have the radio code.
- Write down radio code here if applicable _____.
- If installing an external push button switch, go over the location with the vehicle owner and make sure it is in an accessible place.
- To avoid accidental battery drainage, turn off the interior lights or remove the dome light fuse.
- Roll down a window to avoid being locked out of the car.
- Set Parking brake.
- Remove the negative battery cable if necessary.
- Always secure the interface with Velcro or double-sided tape to prevent rattling or damage.
- Make sure that the panels fit correctly.
- Use electrical tape on all your connections and splices, do not leave any exposed wires.
- Route all wires along with factory harnesses. Do not drill or make any unnecessary holes.
- Always use the help of a professional installer to prevent any damage to the vehicle or the interface.

What's In The Box?

Interface
(Part # NAVRGB6.0-VI)

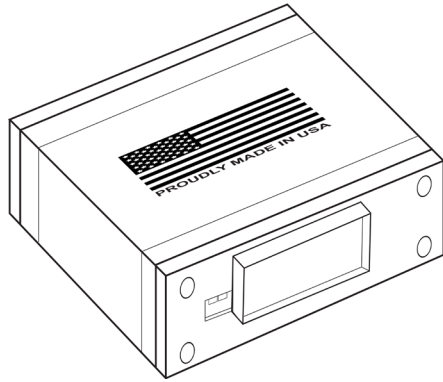

Push Button
(Part # NT-PUSH-BTN)



Interface Harness
(Part # NT-WHNT6)

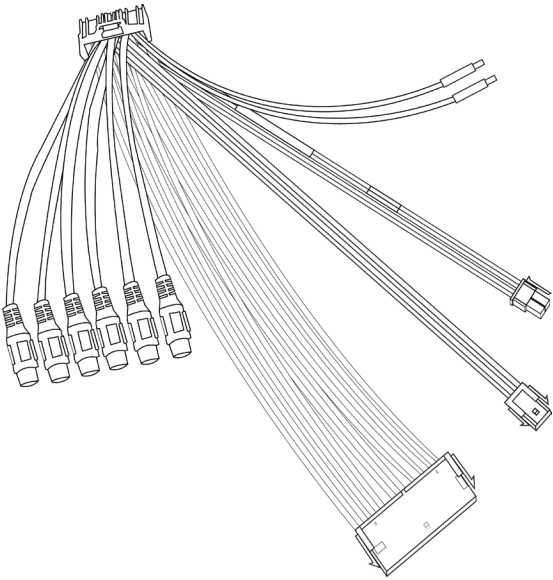

Vehicle Specific
Plug and Play Harness
(Part # NT-HONIRC1)

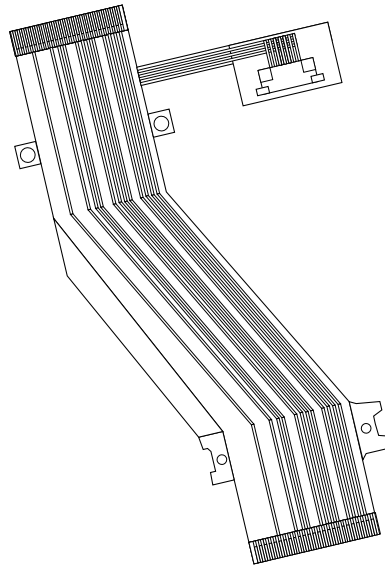

Vehicle Specific
Plug and Play Harness
(Part # NT-LONG-RIB)

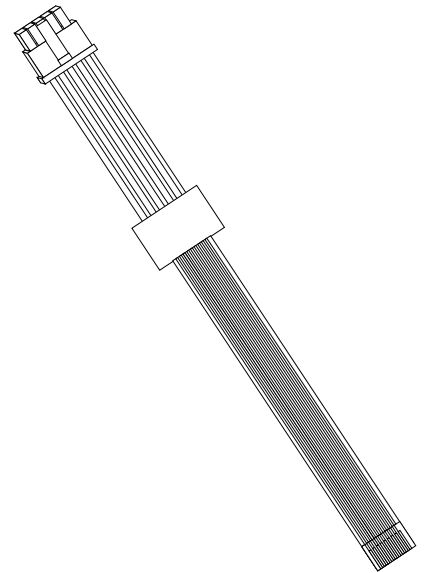

Installation Instructions

Step 1: The Honda headunit is equipped with a anti-theft radio code. Prior to start of the installation, get the radio code. With the vehicle's ignition on and the navigation unit on, press the "OPEN" button.



Step 2: With the display open, disconnect and remove the navigation unit from the vehicle and place it on a flat surface, workbench would work the best for this application. On the back of the LCD screen, remove the screw and the plastic cover located over the factory ribbon cable.



Installation Instructions

Step 3: Disconnect the factory ribbon cable by carefully pulling up on the brown release tab.

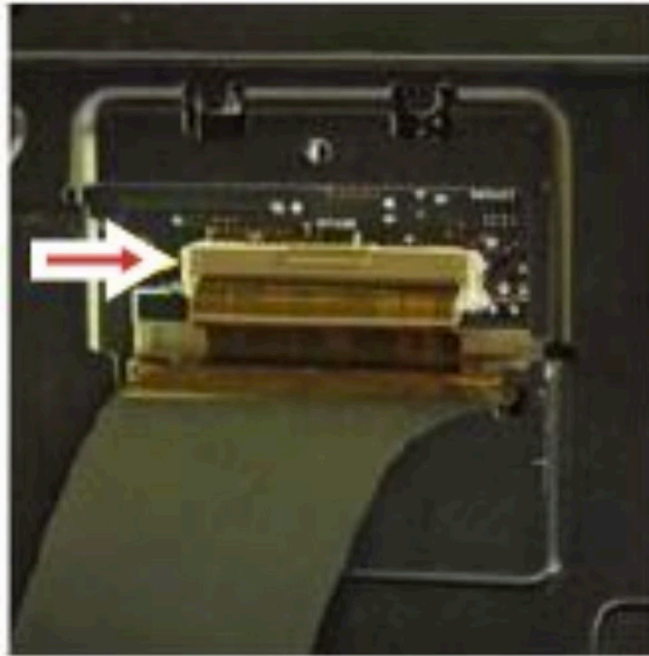

Step 4: Remove three screws on each side of the navigation unit.

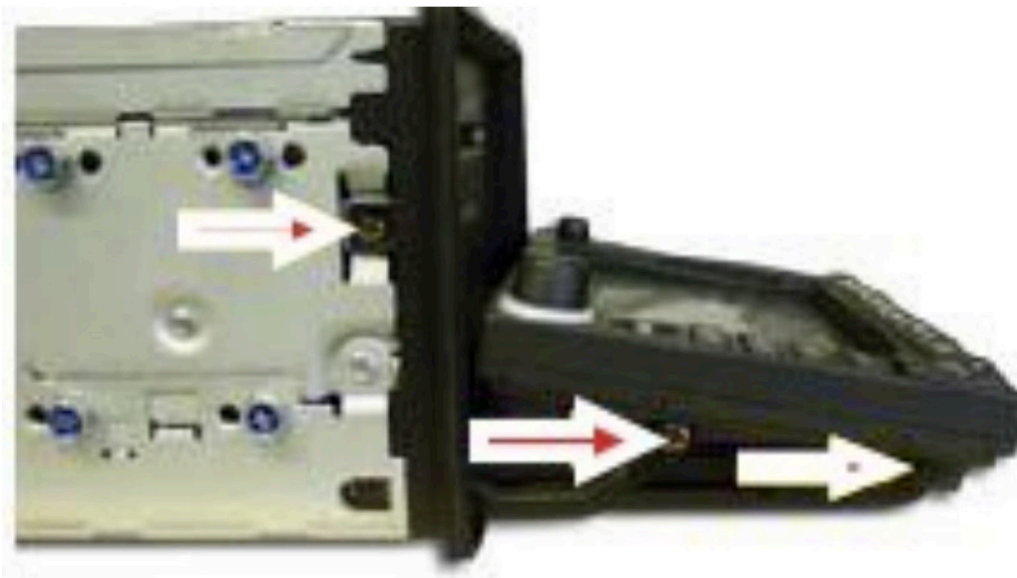

Installation Instructions

Step 5: Remove two screws from the plastic trim cover.



Step 6: Gently remove the plastic trim cover by pushing on the release tabs on all four sides of the navigation unit.



Installation Instructions

Step 7: Remove the black plastic holder by carefully pinching both sides together.

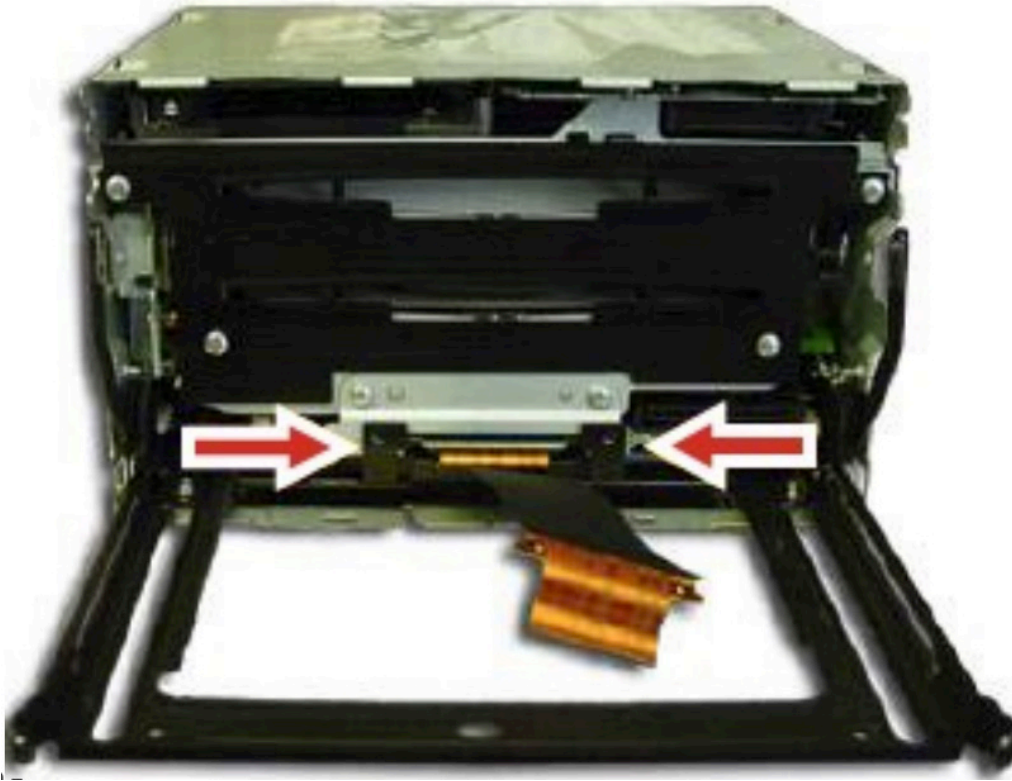

Step 8: Remove the factory flex ribbon cable by gently pulling on the brown release tabs on each side.

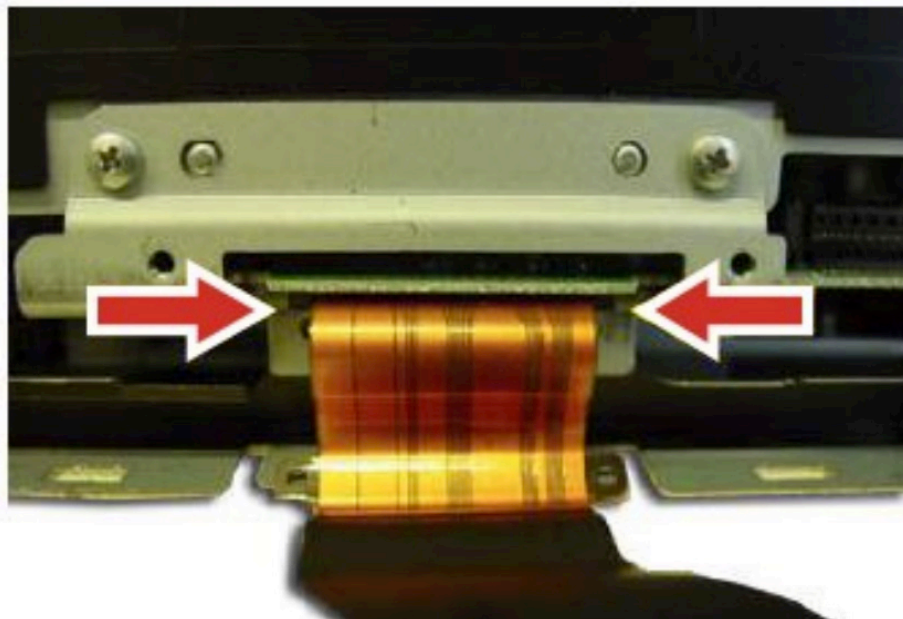

Installation Instructions

Step 9: Place the supplied ribbon cable through the black plastic fastener in the same way the factory ribbon cable originally was with the silver pads facing UP.

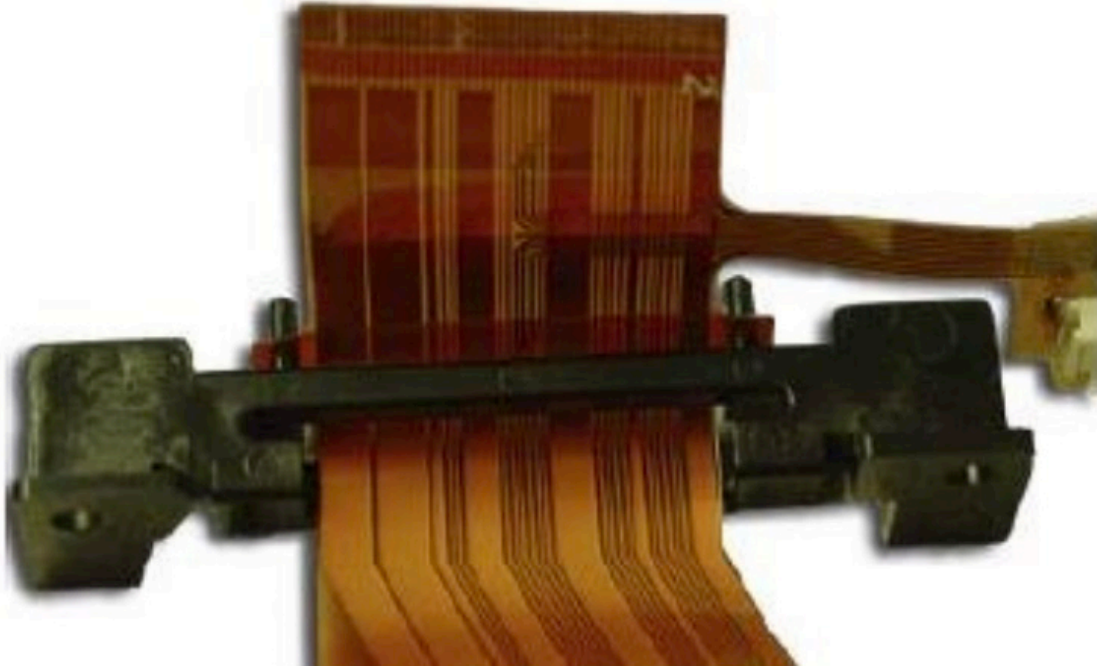

Step 10: Route the supplied small flex ribbon cable thru the back of the radio, under the white connector with silver traces facing DOWN.

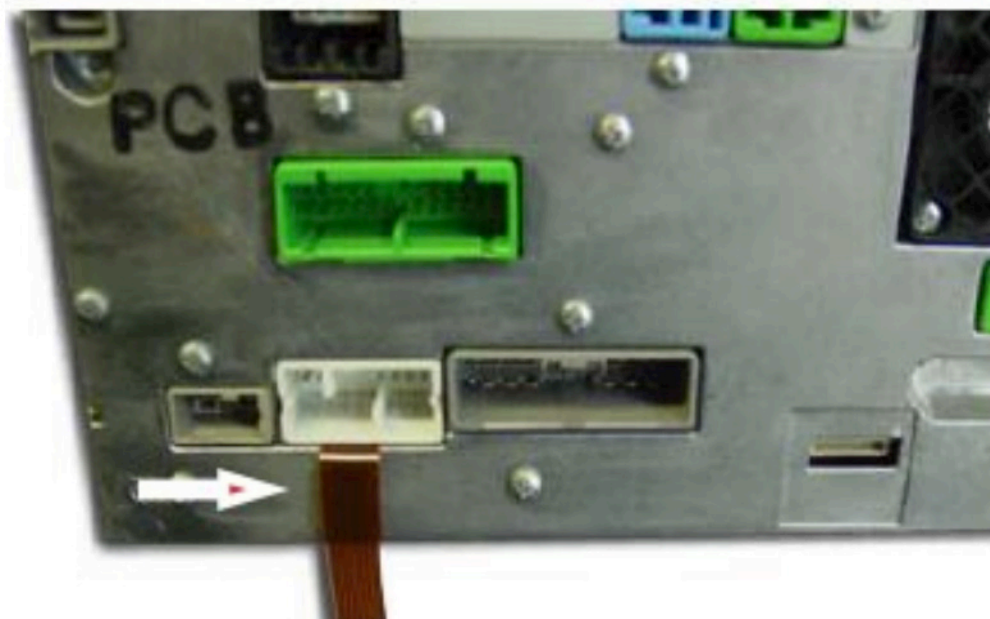

Installation Instructions

Step 11: Connect the supplied small flex ribbon cable to the main flex cable 9 pin connector with the silver traces facing UP. Connect the main flex ribbon cable to the factory navigation with the silver traces facing UP.

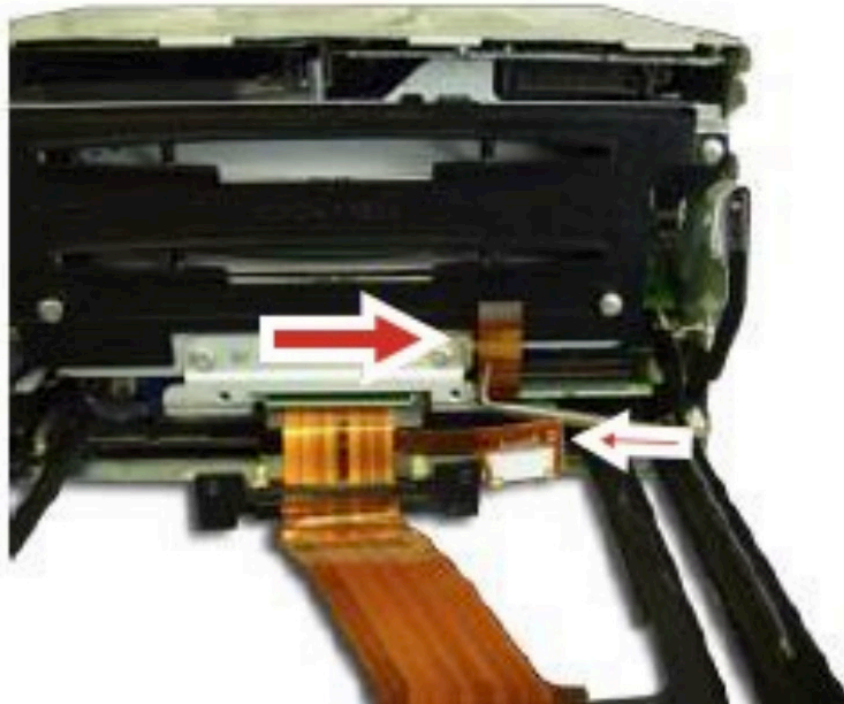

Step 12: Carefully fold the main flex ribbon cable into the factory navigation unit. Secure the main flex ribbon cable with the black plastic holder.

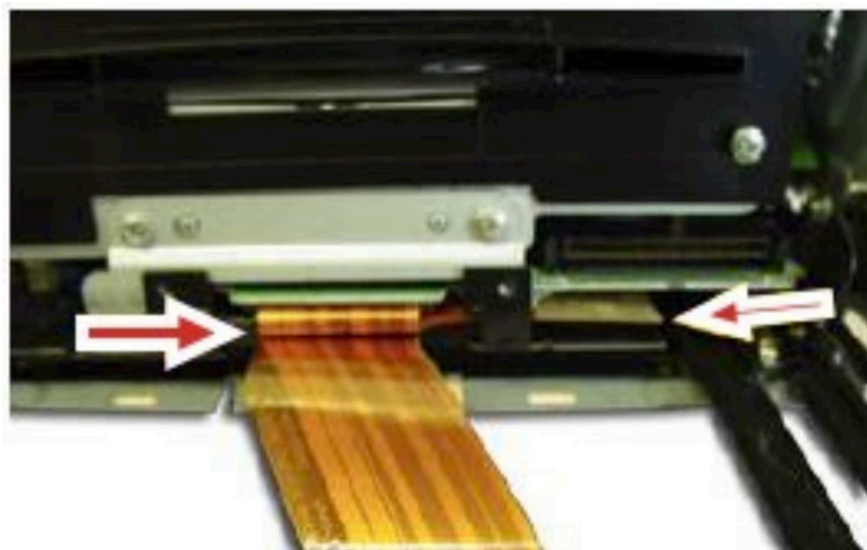

Installation Instructions

Step 13: Assemble the navigation headunit in reverse order of steps, starting from step 6 down to step 1.

Step 14: Connect both 10 pin connectors on the Interface harness and the Vehicle Specific Harness LONG-RIB together.

Step 15: Cut off the Red (+12 Volts ACC) and Black (Ground) wires off of the 6-pin plug on the interface harness.

Step 16: Connect the Red wire (+12 Volts ACC) to the Vehicle's factory accessory wire. (Purple wire on the power plug)

Step 17: Connect the Black wire (Ground) to the Vehicle's factory ground. (Black wire on the power plug)

Step 18: Connect the Orange wire (+12 Volt Reverse Input) to the Vehicle's factory reverse wire. (Rev. Light)

Step 19: Connect one wire of the push button to +12 Volt ACC power in the vehicle and the other wire to the white manual activation wire on the interface harness. (Not required for installations with reverse camera only)

Step 20: Connect your aftermarket cameras/video inputs to Rear Camera Input/Video Input 1 and Front Camera Input/Video Input 2 on the interface harness.

Step 21: Make sure both dip switches on the interface are facing UP in the OFF Position. Plug the interface harness into the interface.

See Next Page for Quick Connection Diagram >

Quick Connection Diagram

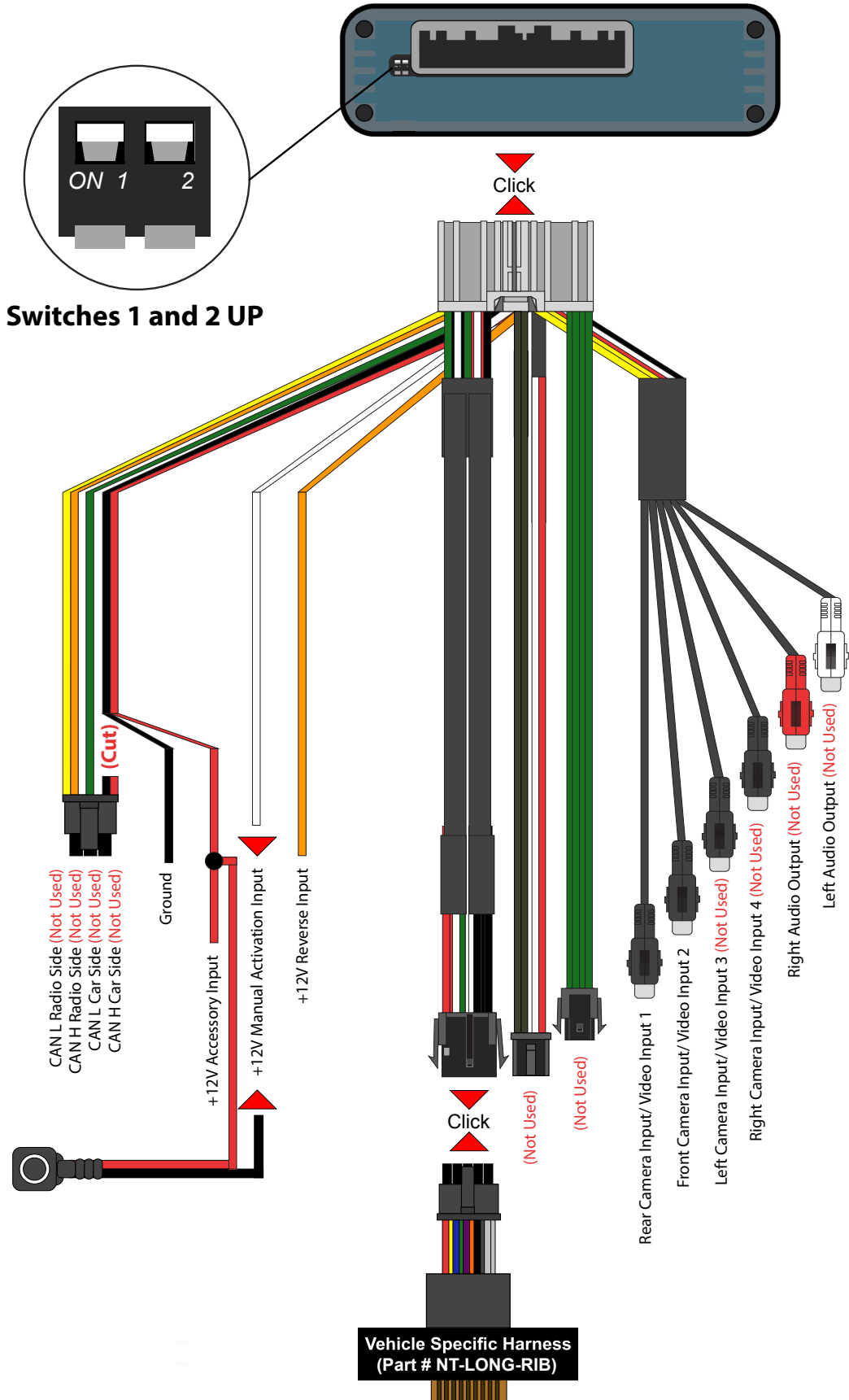

Testing and Operation

Step 1: Turn on the ignition. A green LED will light up on the interface to confirm it has power.

Step 2: Press the push button once to turn on and display Video 1. Skip this step if only using reverse camera. (If no video source is connected you will see a “no signal” message)

Step 3: To return to the factory information screen press and hold the push button for 2 seconds

Step 4: To test the aftermarket reverse camera operation, press on the brake and set the vehicle in reverse. The reverse camera will display. if no camera is connected a “no camera connected” message will appear.

To Turn On parking lines, place vehicle in reverse and hold 12 volts to the white wire until the lines Turn On.
To Turn Off parking lines, place vehicle in reverse and hold 12 volts to the white wire until the lines Turn Off.

User Manual



You do not need to use the push button if only a reverse camera was installed

The reverse camera will automatically display when the vehicle is placed in Reverse. It will automatically Turn OFF when the vehicle is placed in any other gear and will display the factory screen.

To View Video 2 (Front Camera if Installed)

If no video source is connected you will see a "No Signal" message.

Step 1: Press the push button once to Turn ON the interface. This will display Video 1.

Step 2: Press the push button once to switch from Video 1 source to Video 2 source.

Step 3: Press and Hold the push button for 2 seconds to return to the factory screen.