



**USER GUIDE**

---

**DZ-30**

|   |    |
|---|----|
| Foreword.....                                     | 1  |
| 1. Product introduction.....                      | 2  |
| 1.1 Product model.....                            | 2  |
| 1.2 Product description.....                      | 2  |
| 1.3 Appearance and size.....                      | 3  |
| 1.4 Numbering rules of display.....               | 3  |
| 1.5 Display interface.....                        | 4  |
| 1.6 Specification parameter.....                  | 4  |
| 1.7 Function overview.....                        | 5  |
| 1.8 Wiring definition.....                        | 5  |
| 2. Product operation instruction.....             | 5  |
| 2.1 Installation instruction.....                 | 5  |
| 2.2 Definition of key.....                        | 6  |
| 2.2.1 Power on/off.....                           | 6  |
| 2.2.2 Power-assisted gear shift.....              | 6  |
| 2.2.3 Displayed information switching.....        | 7  |
| 2.2.4 Walking-assisted mode.....                  | 7  |
| 2.2.6 Battery indicator.....                      | 8  |
| 2.3 User setting.....                             | 8  |
| 2.3.1 Enter setting interface.....                | 9  |
| 2.3.2 Backlight brightness setting.....           | 9  |
| 2.3.3 Unit setting.....                           | 9  |
| 2.3.4 Voltage setting.....                        | 10 |
| 2.3.5 Auto-sleep duration setting.....            | 10 |
| 2.3.6 Wheel diameter setting.....                 | 10 |
| 2.3.7 speed limited setting.....                  | 10 |
| 2.3.8 Exit setting.....                           | 10 |
| 3. Common problems and solutions.....             | 11 |
| 3.1 error hint.....                               | 11 |
| 3.1.1 Error display.....                          | 11 |
| 3.1.2 Error code, investigation and analysis..... | 11 |
| 4. Attention.....                                 | 12 |
| 5. Quality commitment and warranty scope.....     | 12 |
| 6. Change explanation of document version.....    | 13 |

## Foreword

Dear user, in order to make you operate the e-bike better, please read the instruction of DZ30 carefully before using. We' ll inform you every step of the display in the most concise language, from the installation of hardware to the normal use of the display, and help you solve the confusion and obstacles that may occur in the use of the display.

# 1. Product introduction

## 1.1 Product model

LCD for booster, model: DZ30

## 1.2 Product description

- ◆ Compact and minimalist shape design.
- ◆ Wide angle of display, 1.3" LCD-FSTN (Negative) the display is very clear.
- ◆ waterproof and dusty-proof level: IP65
- ◆ Compatible with the mainstream UART protocol, it can be switched between multiple protocols and matching better.

## 1.3 Appearance and size

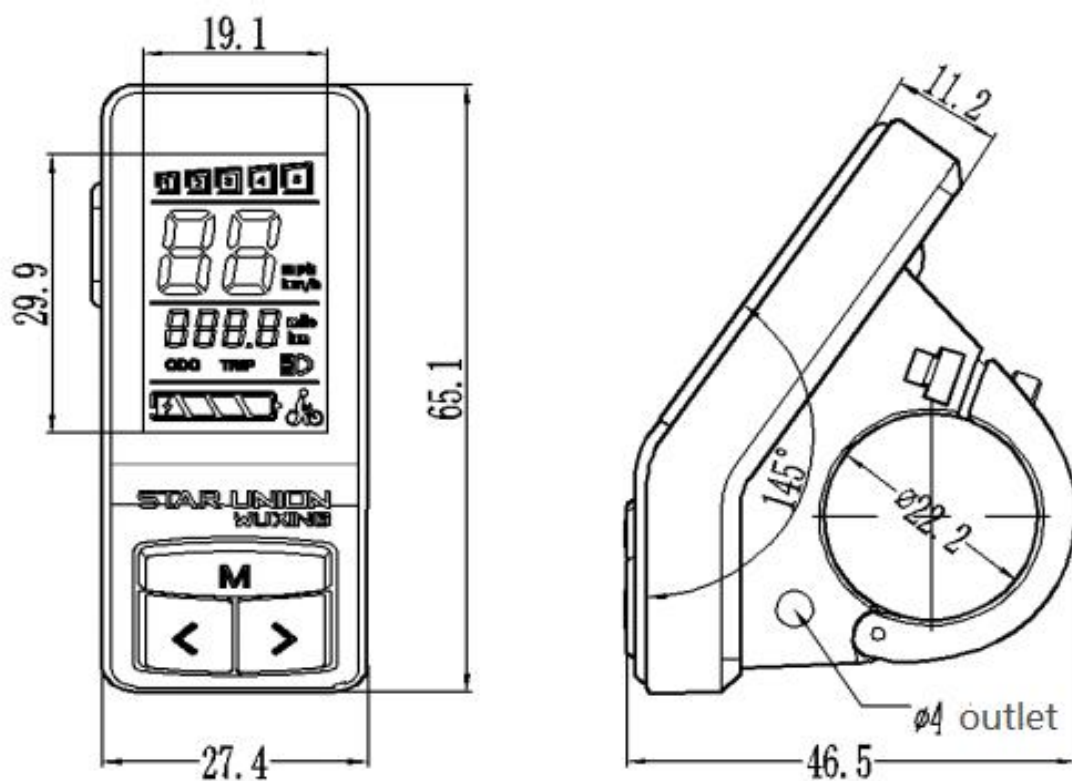

## 1.4 Numbering rules of display

1.4.1 Production number of regular display order

| Production Number                       | Voltage Value  |
|---|--|
| Marking                                 | Meaning  |
| Specific year, month, day of production | Regular voltage value: 24v, 36v, 48v, or other voltage values as the requirement of customers. |

20XX-XX-XX ——— specific year, month, day of production

XX-V ——— voltage value

1.4.2 Display numbering rules of SN Program software

| Display software code |                 | Model         | Customer code                         | Software version               |
|-----------------------|-----------------|---------------|---------------------------------------|--------------------------------|
| character             | meaning         | meaning       | meaning                               | meaning                        |
| WXRJ                  | Wuxing software | Display model | Abbreviation of customer company name | Software version serial number |

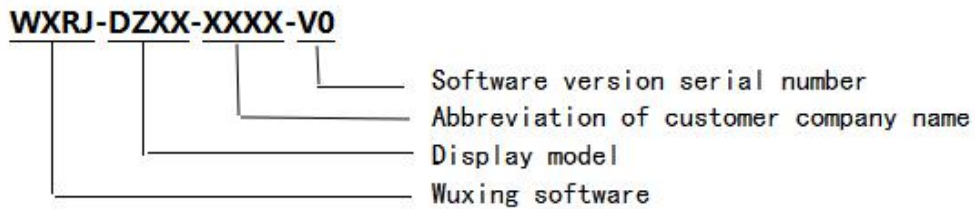

1.5 Display interface



### 1.6 Specification parameter

- ①: Power supply voltage: DC 24V/36V/48V
- ②: Rated current: 15mA~25mA /36V, electric door lock output: MAX100mA@(19V~54V)
- ③: Screen specification: 1.3 inches LCD(FSTN) negative
- ④: Communication mode: UART (default Star Union Protocol)
- ⑤: Operating temperature: -20° C~ 60° C
- ⑥: Storage temperature: -30° C~ 75° C
- ⑦: waterproof and dust-proof level: IP65
- ⑧: Service life of key: >50,000 times

### 1.7 Function overview

- ①: Four keys, easy operation.
- ②: Km/mile mode switchable.
- ③: Mileage display: subtotal mileage (TRIP) 、 total mileage (ODO)
- ④: Walking-assisted mode: 6KM/H
- ⑤: Power-assisted modes selection
- ⑥: Four stages electricity indicator
- ⑦: Headlight hint
- ⑧: Fault code hint

### 1.8 Wiring definition

The output line of DZ30 is 5 core wiring, the wiring definition is as follows, the connectors are defined according to the customer requirements.

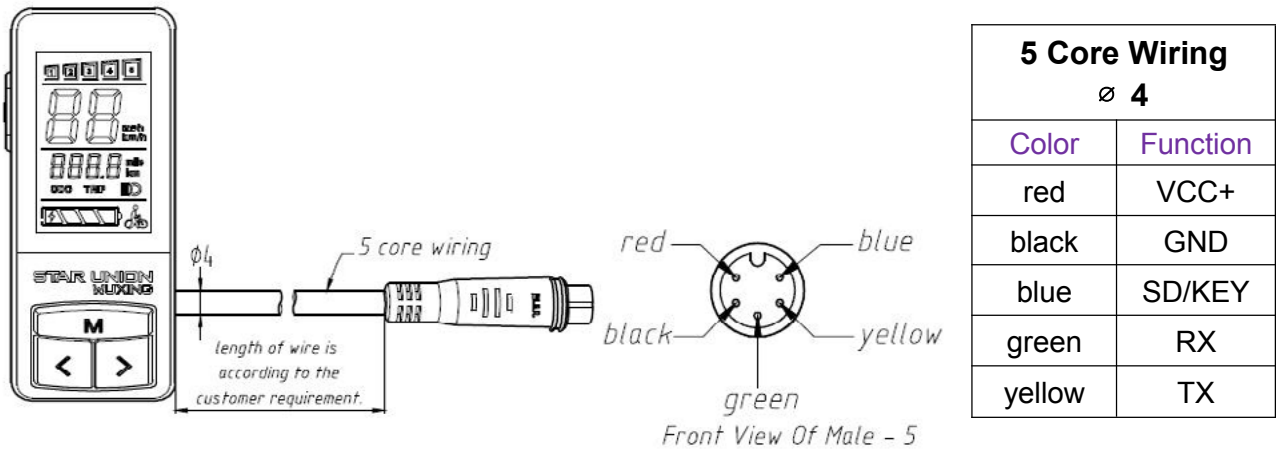

## 2. Product operation instruction

### 2.1 Installation instruction

- ① Open the locking ring, put it on the left handle (standard specification of handle:  $\Phi 22.2$ ), adjust display to the easy-operation position, then tighten the set screw by M3 Inner hexagonal. Torque: 0.8N.m. Display be damaged caused by excessive torque is not covered by warranty.
- ② Connect the 5pin plug-in of display with the controller plug-in according to the marking.

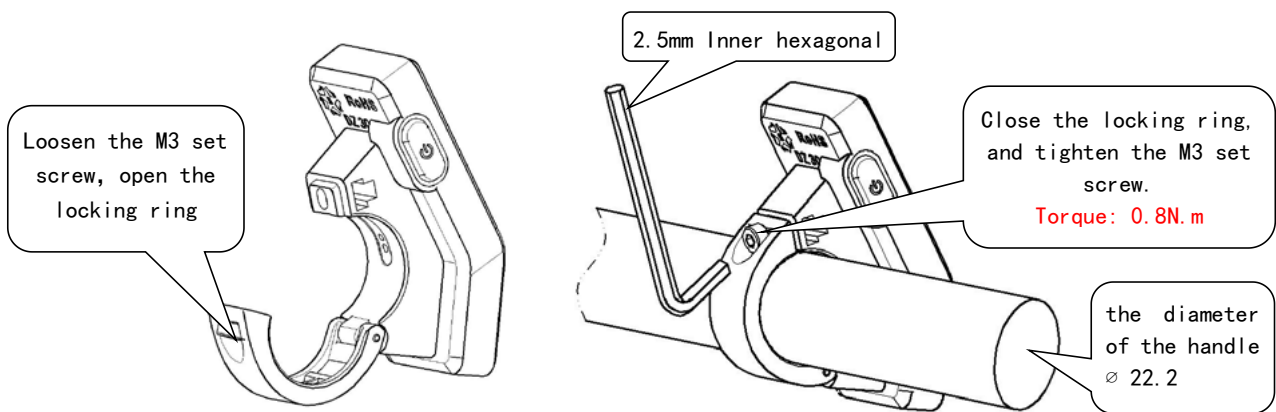

### 2.2 Definition of key

power on/off: , function key: **M**, adjusting key: **<**, adjusting key: **>**.

### 2.2.1 Power on/off

Keep the display in normal connection with the controller, the display will turn on when you long-press the  key about 2s in the power off state.

The display will turn off when you long-press the  key about 2s in the power on state.

### 2.2.2 Power-assisted gear shift

Press the key < 或 > can shift the gear and change the power-assisted mode, it's totally 0~5 gear modes: default 0 gear in the power on state(no sign), it's no power-assisted gear when it display "0". (The selection interface of the gear is as follows)



### 2.2.3 Displayed information switching

Short-press the M key can switch the subtotal mileage, total mileage, Fault monitor: subtotal mileage(TRIP)-> total mileage(ODO)-> Fault monitor(E00). The mode switching interface is as follows:





### 2.2.4 Walking-assisted mode



Enter the walking assisted mode by long-pressing the “<” key about 3s, the lower right corner will show the icon  , it will exit the walking-assisted mode when you release the button. The interface of walking-assisted mode is as follow(only in the push state):



### 2.2.5 Headlight switch

The headlight will be turned on by short-press the  key about 1s (need the support of controller) , and the headlight icon on the display interface will be lighted, then the headlight will be turned off by long-press the  key about 1s, and the headlight icon goes out.







### 2.2.6 Battery indicator

When the battery power is normal, there are four squares of the battery indicator according to the battery capacity change. The last square flashes when the battery power reaches the under-voltage warning value, it flashes for reminding the users to charge immediately. The battery indicator is as follows:



Battery capacity (C) percentage and icon corresponding table (allowable error:  $\pm 0.5V$ )

| NO. | Percentage of electricity | Electricity display   | 24V                  | 36V                  | 48V                  |
|-----|---------------------------|---|----------------------|----------------------|----------------------|
| 1   | $C \leq 5\%$              |  | $U \leq 23.1$        | $U \leq 33$          | $U \leq 42.9$        |
| 2   | $5\% < C < 30\%$          |  | $23.1 \leq U < 24.5$ | $33 \leq U < 34.8$   | $42.9 \leq U < 45.5$ |
| 3   | $30\% < C < 50\%$         |  | $24.5 \leq U < 25.5$ | $34.8 \leq U < 36.7$ | $45.5 \leq U < 47$   |
| 4   | $50\% < C < 70\%$         |  | $25.5 \leq U < 27$   | $36.7 \leq U < 38.5$ | $47 \leq U < 50.1$   |
| 5   | $C \geq 70\%$             |  | $U \geq 27$          | $U \geq 38.5$        | $U \geq 50.1$        |



### 2.3 User setting

General setting items: backlight brightness, unit, voltage, automatic shutdown time, wheel diameter, speed limit information, etc. (other setting items are associated with controller or have default settings)

#### 2.3.1 Enter setting interface

Enter the setting item by pressing the “< >” keys about 3s at the same time in the power-on interface, enter the parameter setting by pressing the “

#### 2.3.2 Backlight brightness setting

Enter the setting interface, the mileage position displays P00, press the key “<” to P01. Press the key “

#### 2.3.3 Unit setting

Enter the setting interface and adjust to P02, press “

Range: ‘0, 1’

0: Km unit- KM    KM/h

1: mile unit- mile    mph

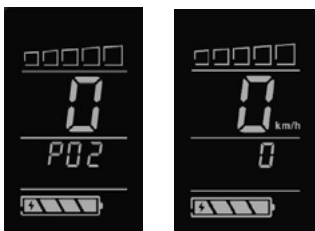

### 2.3.4 Voltage setting

Enter the setting interface, and adjust to P03, press “

Range: ‘24, 36, 48, 60’ , unit: V

### 2.3.5 Auto-sleep duration setting

Enter the setting interface and adjust to P04, press the “

Range: ‘0-255’ , unit: minute

When the value is 0 means turning off the auto-sleep mode.

### 2.3.6 Wheel diameter setting

Enter the setting interface and adjust to P08, press the “

Range ‘1.0-50.0’ , unit: inch

### 2.3.7 speed limited setting

Enter the setting interface and adjust to P10, press the “

Range: ‘0-255’ (speed limited of Eight-part Communication Protocol is set by controller)

### 2.3.8 Exit setting

When you have finished setting, press the “< >” keys at the same time about 3s

to exit the setting mode.

### 3. Common problems and solutions

● Display cannot be turned on

Check whether the wiring is correct or not, the plug-in is installed in place or not, the power output is normal or not.

● The display show an error code

Go to the e-bike maintenance point in time for maintenance.

● The display speed does not match the actual speed

Check whether the wheel diameter and the magnetic steel setting is in line with the real vehicle.

#### 3.1 error hint

When the function of the e-bike is lost or cannot run normally, you can analyze and monitor the current fault causes of e-bike by viewing the error code of display. Press the “M” key for viewing the fault error code and analyzing the cause.

##### 3.1.1 Error display

Display E00~E09 at mileage position under the fault interface (E00 means monitor normal)

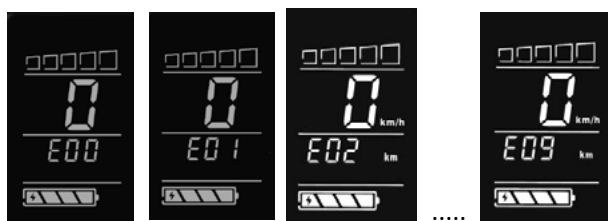

##### 3.1.2 Error code, investigation and analysis

| Error code | Description of error  | Investigation and analysis  |
|------------|---|---|
| E01        | The data that the display cannot receive from the controller or the data received is error. Communication fault | 1. Check that the TX,RX communication line is connected correctly. 2. Check if the harness and connector are loose or broken. 3. Check that if the display communication protocol |
| E02        | The controller cannot receive data from display or the data received is error. Communication fault              |   |

|     |   |                                |
|-----|---|--------------------------------|
|     |   | matches.                       |
| E03 | Controller fault                                      | Check the controller           |
| E04 | Motor hall fault                                      | Check the motor                |
| E05 | Motor phase fault                                     | Check the motor                |
| E06 | Throttle fault  | Check the throttle             |
| E07 | Brake fault   | Check the brake                |
| E08 | Sensor fault  | Check the sensor               |
| E09 | The motor is in the state of under-voltage protection | Charging and check the battery |

#### 4. Attention

★Don' t knock on the LCD window area to avoid the LCD screen cracking or shell cracking thus cause water or electric leakage, use display in safe way.

★Try to avoid using it in bad weather conditions, such as heavy rain, heavy snow, sun exposure.

★The plug-in of display cannot be disconnected in the power on state to avoid the display been burned out.

★The display cannot be soaked in the water to avoid short-circuit, and cannot contact with fire to prevent the plastic shell from melting, resulting in LCD screen cracking and environmental pollution.

★The display shall be connected according to the color definitions of wires, and it can not be wired freely to prevent the display from being burnt out.

★Send to recondition in time when the display can' t be used normally.

#### 5. Quality commitment and warranty scope

(1) After delivered, Scratches, breakage and breakage of the shell and wires are not covered by warranty.

The display been burned out due to the wrong wiring of customer, not in the scope of warranty.

---

## 6. Change explanation of document version

The display instruction manual is the DZ30-v1.0 general software setting version of Jiande Wuxing Bicycle Co., Ltd., specific according to the actual setting of the customers' vehicle .

| Version | Date       | Change description | Edit | Verify | Approval |
|---------|------------|--------------------|------|--------|----------|
| V1.0    | 2019-10-06 |                    | 刘锦前  |        |          |