

**HOW TO  
PUT THIS  
SH\*T  
TOGETHER**

**TUSHY SPA 3.0**



**TUSHY**

hellotushy.com

# TABLE OF CONTENTS

MEET THIS MANUAL .....	1-2
MEET YOUR TUSHY .....	3-6
BEFORE YOU START .....	7-11
GET THIS POTTY STARTED .....	12-14
CONNECTING YOUR TUSHY .....	15-31
KNOW BEFORE YOU GO .....	32
HOW TO USE YOUR TUSHY .....	33
FREQUENTLY ASSED QUESTIONS .....	34
TROUBLESHOOTING .....	35-36
WARRANTY .....	37
MEET THE TUSHY POO-RUS .....	38

# MEET THIS MANUAL

## GET INTO THE GROOVE



Let's get this POTTY STARTED! Turn on some rump shakin' TUSHY Tunes. We've assembled the perfect tracks to get you in the mood to upgrade your toilet, your booty and your life.

[HELLOTUSHY.COM/TUNES](https://www.hellotushy.com/tunes)

## GET COMFY



Lay down a towel or the TUSHY box for some extra padding for your knees.

## USE THE QR READER



You'll find, next to every step of this installation, an itty-bitty funky looking square like this. This is a QR code.

Scan this with your phone to see a handy visual of the steps. Technology, right?

Using your app or the camera, hold your smartphone camera over the QR Code so that it's clearly visible within your screen.

## CONTACT US

Have a question?

Our Customer Experience Poo-rus are ready to help.

Email us at [INSTALL@HELLOTUSHY.COM](mailto:INSTALL@HELLOTUSHY.COM)

## IMPORTANT STUFF

*Read all instructions before installing or using the TUSHY. Failure to do so could result in property damage. Always turn off the water supply valves before installing or performing maintenance on your TUSHY. Use caution when handling the warm water supply valve, as it may be hot. When tightening connections, make sure they are tight, but be careful not to over-tighten as this could result in leaks or property damage. Make sure you check for leaks after installing your TUSHY and periodically thereafter. When using your TUSHY, turn the pressure knob slowly. Increasing the pressure too fast may lead to discomfort or injury. Be careful to test the water temperature before use. Failure to do so could result in injury.*

# MEET YOUR TUSHY

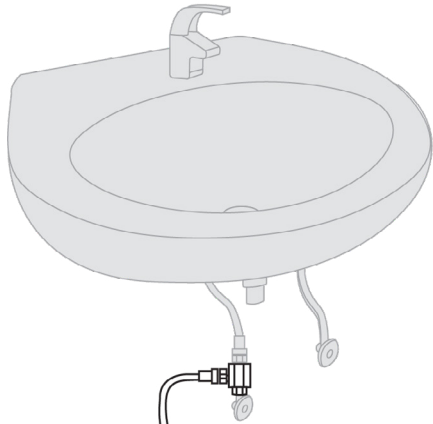

3

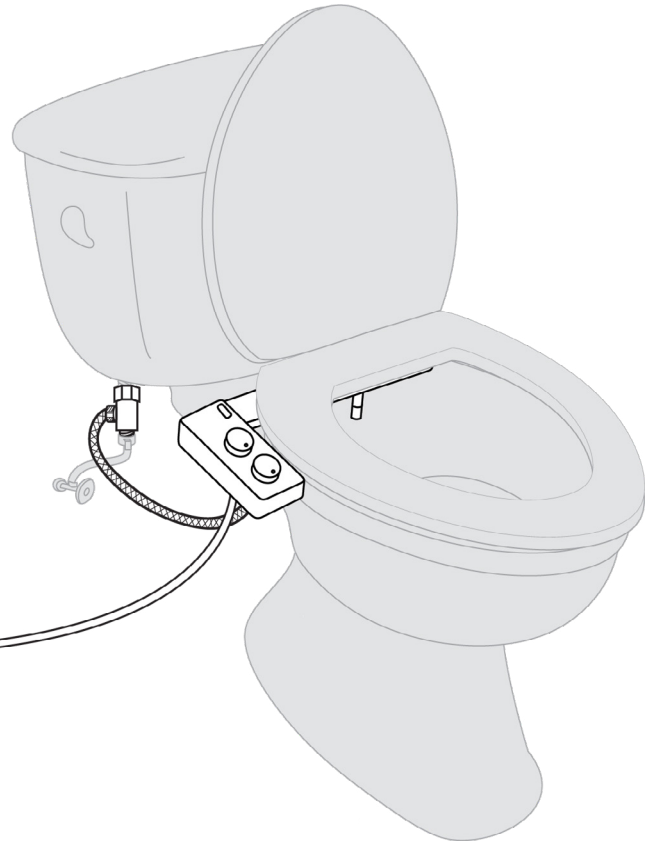

4

# YOUR TUSHY

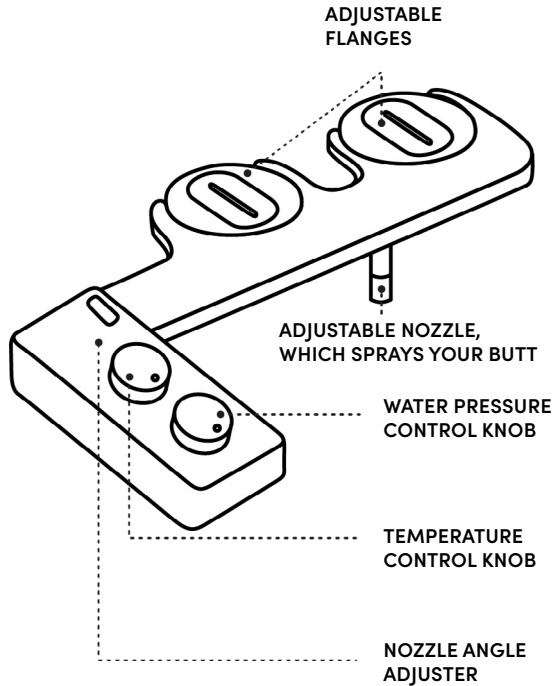

# INCLUDED PARTS

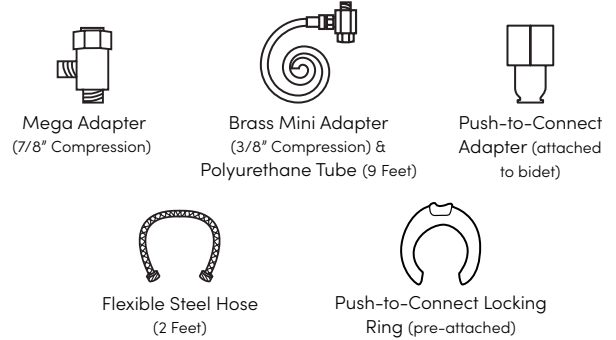

# INCLUDED EXTRA PART



Inlet Cap

## **TUSHY TIP:**

Keep all of these parts (and this manual) just in case you need them in the future!

# YOU MIGHT ALSO NEED

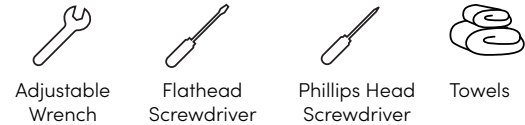

# BEFORE YOU START

## CHECK YOUR TOILET

(THERE ARE DIFFERENT KINDS OF TOILETS? WHO KNEW?)

To check out these toilets  
online, scan here:



### THE STANDARD

MOST POPULAR

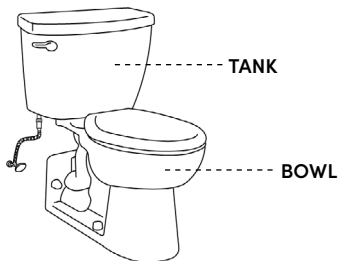

The Standard “two-piece” toilet is the most common toilet you’ll find in a majority of residential homes. It comes in two pieces, consisting of the bowl and the tank, and has a flexible steel hose connection between the water supply and tank. Most importantly, all of the water supply connections are visible. If you’ve got The Standard, then this install will be easy breezy. You’re good to go!

### THE SKIRTED TOILET



TANK

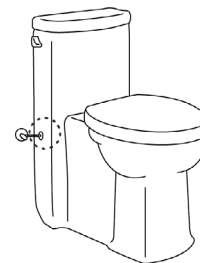
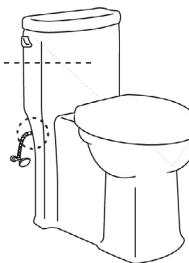

Skirted toilets are a more modern, clean design that may hide the external tank connection. If you are able to access the tank connection, awesome! You shouldn’t have too much trouble.

If you aren’t able to access the tank connection, check out [HELLOTUSHY.COM/SKIRTEDTOILET](https://www.hellotushy.com/skirtedtoilet) for tips on how to connect these toilets. We’ll get you set up in no time.

## THE FLUSHOMETER

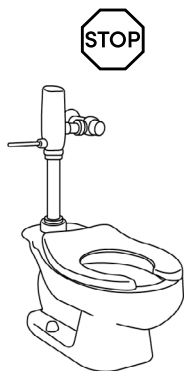

The flushometer toilet is the kind that you normally find in commercial buildings, but some (looking at you, NYC friends) residential apartment buildings have these toilets. They have a lever with a powerful flush and no easy access to a water supply connection. At first glance, these toilets don't look TUSHY compatible BUT... we have a hack for that. ;)

You can connect your TUSHY to your sink's water supply. Make sure your sink is within 15 feet of your toilet. If you want to start a flushometer installation, visit our flushometer page [hellotushy.com/flushometer](https://hellotushy.com/flushometer) for an instruction video and parts you will need.

If you have any questions at all, email [INSTALL@HELLOTUSHY.COM](mailto:INSTALL@HELLOTUSHY.COM), and we will be able to ASSist you.

## THE FRENCH CURVE

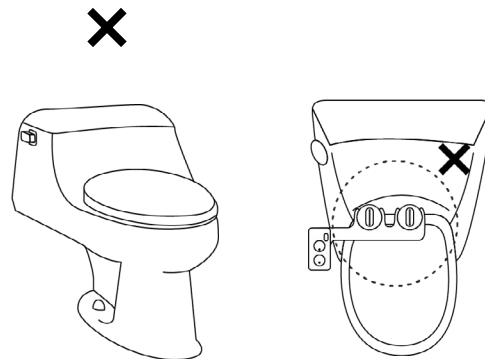

Do you Oui Oui in this type of potty? French Curve toilets are one-piece toilets curved in the back. Though they are very high-end, French curve toilets tend to be very hard to fit when it comes to any bidet seats or attachments. The back of TUSHY bidet attachments is a bit too long to fit in front of the sexy curves.

If you have any questions at all, email [INSTALL@HELLOTUSHY.COM](mailto:INSTALL@HELLOTUSHY.COM), and we will be able to ASSist you.

## CHECK YOUR CONNECTION

### WHAT KIND OF WATER CONNECTION DOES YOUR TOILET HAVE?

If you have a flexible hose (left), you're good to go! Do you have a rigid metal or plastic pipe instead (right)? No problem, visit [HELLOTUSHY.COM/FLEXHOSE](https://www.hellotushy.com/flexhose) or visit your local hardware store to get a flexible hose. You'll want a flexible steel hose that's 3/8" x 7/8".

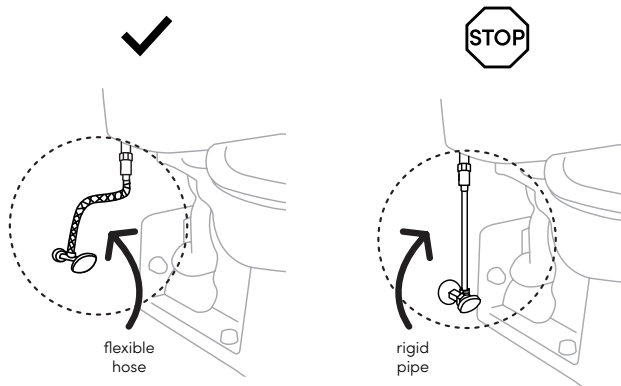

If you have any questions at all, email [INSTALL@HELLOTUSHY.COM](mailto:INSTALL@HELLOTUSHY.COM), and we will be able to ASSist you.

## GETTING THIS POTTY STARTED

### 1.

### TURN OFF WATER SUPPLY VALVES



#### 1a.

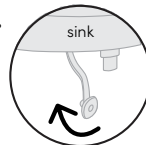

Turn off the warm water valve beneath the sink by turning it clockwise.

⚠ **CAREFUL!** It might be hot.

#### 1b.



Then, turn off the water valve beside the toilet by turning it clockwise.

### TUSHY TIP:

If the valves are tight, there may be some mineral buildup (white calcification) - slow and steady wins the race. If it's stuck, try twisting it in one direction and then the other, each time rotating a little further until it's free to turn all the way around.



## 2.

### EMPTY THE TOILET TANK

Flush your toilet to drain the tank. Hold down that flusher until the tank empties nearly completely!

An inch of water at the bottom of the tank is OK, though.

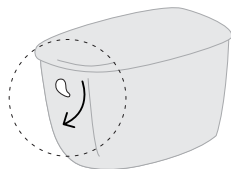

## 3.

### REMOVE THE TOILET SEAT



For most toilet seats, flip up the screw caps behind the seat with a flathead screwdriver to access the screws. Turn counter-clockwise to loosen the screws. Remove the seat and set aside. You won't need the seat until Step 7.

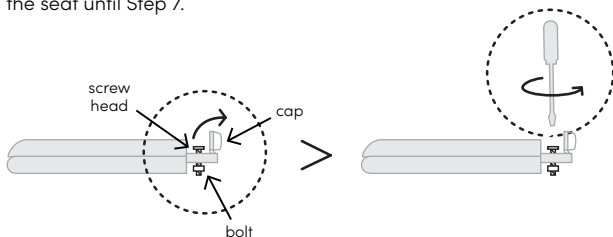

#### TUSHY TIP:

You may need to hold the bolt on the underside of the screw with your other hand (using pliers or a towel) while unscrewing.

#### Dealing with a unique quick-release or mounted toilet seat?



There's a super easy fix. The quick-release mounts should be able to unscrew from the toilet. Just remove them and set them aside for now.

Check out [HELLOTUSHY.COM/MOUNTEDSEATS](https://www.hellotushy.com/mountedseats) for some video tips if you're having trouble.



#### TUSHY TIP:

If your toilet is dirty (hey, it happens!), it's the perfect time to clean it.

# CONNECTING YOUR TUSHY

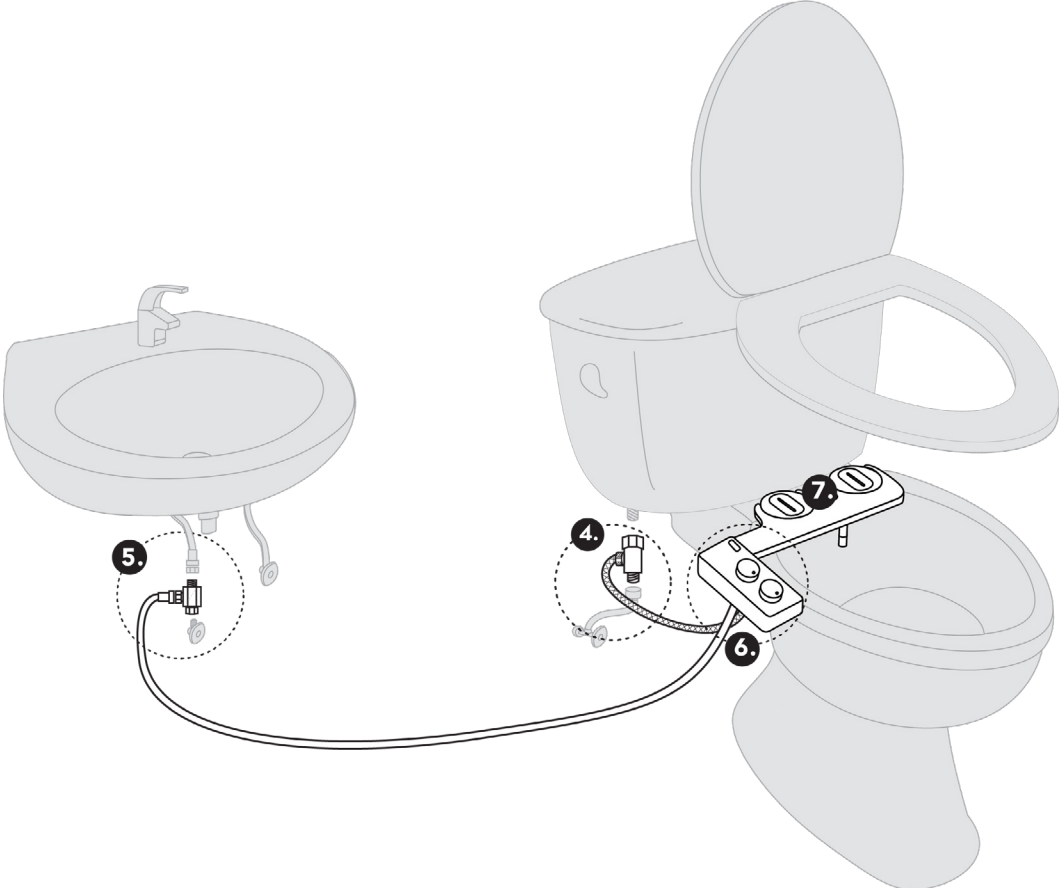

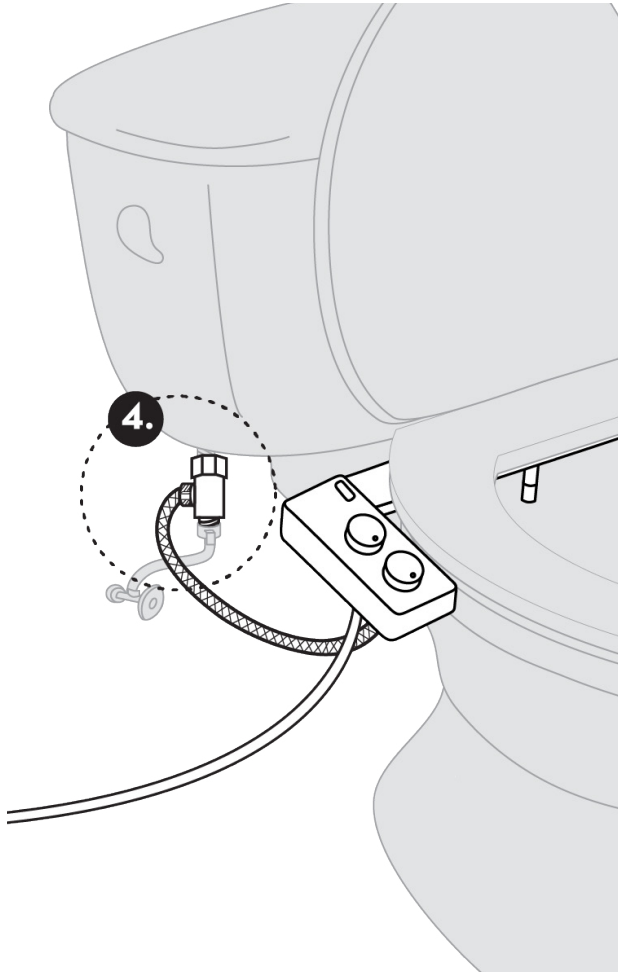

## 4. CONNECT TO COOL WATER

---

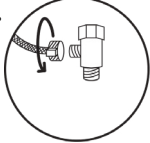
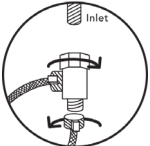

- 4a.**  Disconnect the existing flexible hose from your toilet tank by turning it clockwise. Be prepared to catch or wipe up some residual water that might spill onto the floor.
- 4b.**  Screw the provided flexible steel hose to the mega adapter's side connection. Use a wrench to tighten it if necessary, but remember: don't over-tighten!
- 4c.**  Screw the existing flexible hose to the bottom of the mega adapter and then screw the top of the mega adapter counterclockwise onto the tank. Be careful not to over-tighten!

### **TUSHY TIP:**

Make sure the threads of the mega adapter are lined up with the threads of the cold water hose. If the hose only turns once before stopping, it may be cross-threading and not sealing properly. Unscrew the hose and re-attach until the threads line up properly.

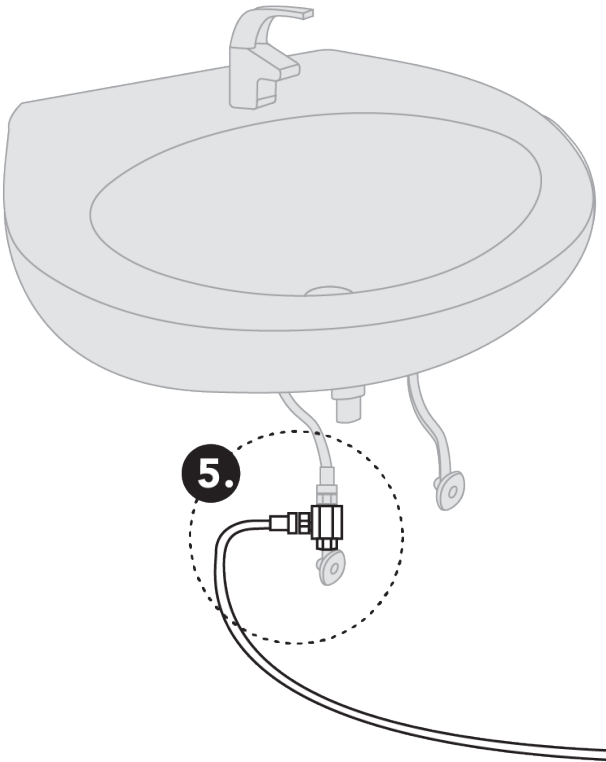

## 5. CONNECT TO WARM WATER

---



5a.

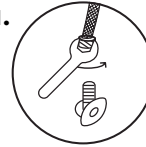

Disconnect the existing flexible steel hose from the warm water supply valve by turning it counter-clockwise.

**Do you have a rigid metal or plastic pipe?**

No problem. Visit [HELLOTUSHY.COM/SINKFLEXHOSE](https://www.hellotushy.com/sinkflexhose) or your local hardware store to get a flexible hose. (You'll want a flexible steel hose that's 3/8" x 1/2".)

5b.

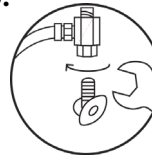

First, check to make sure the black rubber gasket is located inside of the swivel head of the mini adapter. Then, fasten the mini adapter to the warm water supply valve by turning clockwise first using your hand then using a wrench.

Make sure to not over-tighten! The adapter doesn't need a lot of force to seal.

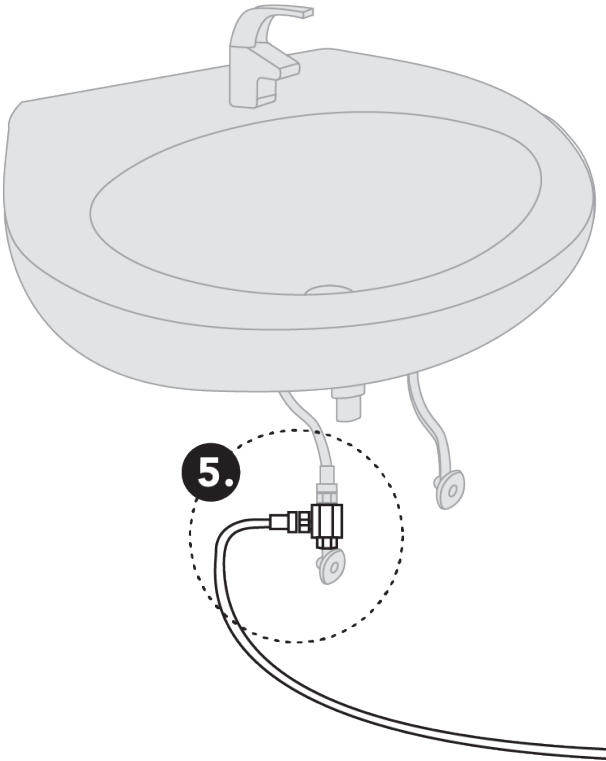

## 5. CONNECT TO WARM WATER

---



(CONT.)

5c.

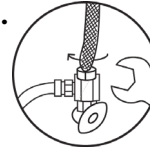

Reconnect the existing flexible steel hose to the top of the mini adapter by turning clockwise using your hand and then using a wrench. Again, make sure to not over-tighten!

### WARM WATER CONNECTION DIDN'T WORK OUT?

We'll convert your TUSHY Spa 3.0 to a TUSHY Classic 3.0. Unscrew the "push-to-connect" adapter from below the console and replace it with the inlet cap provided in the box. Voila! You can save the hot water part of the installation for another toilet, another day and still use TUSHY.

Visit [HELLOTUSHY.COM/INLETCAP](https://www.hellotushy.com/inletcap) for a how-to video.

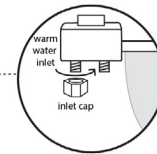
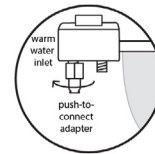

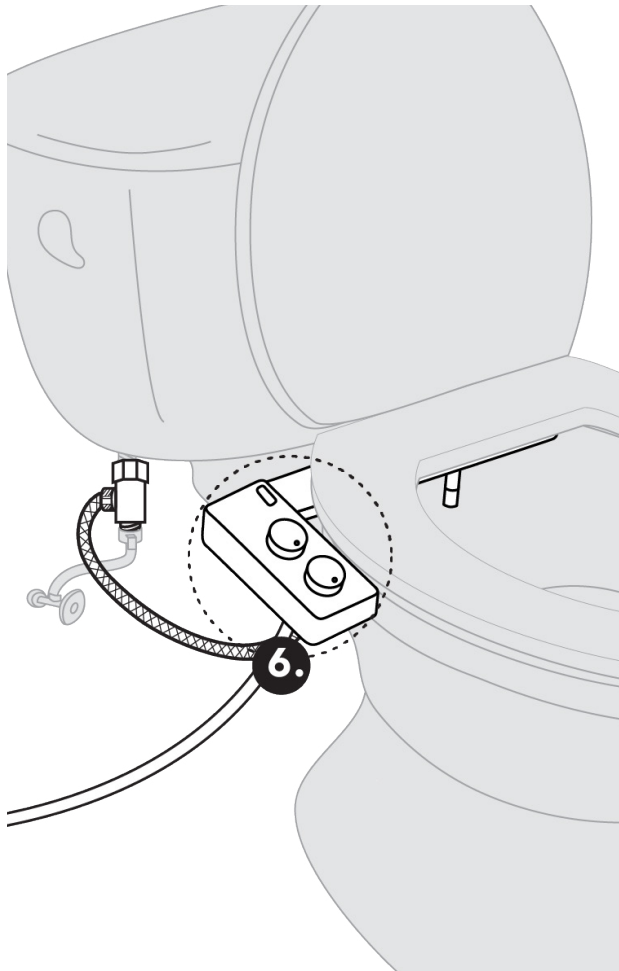

## 6. FINISH THE WATER CONNECTION



### 6a. WARM WATER CONNECTION

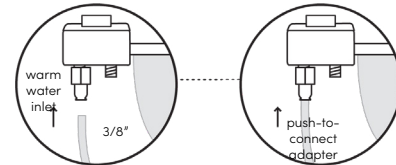

First, use a pen to mark a line  $3/8$ " down from the end of the plastic tube. Then using your fingernail, pop off the white plastic locking ring attached to the push-to-connect adapter. Take the end of the plastic tubing and push firmly into the end of the push-to-connect adapter on the underside of the TUSHY console until you feel it stop. If the mark is no longer visible, then the tube is properly seated inside of the adapter. If it is visible, then continue pushing until it is fully seated. Be careful not to push too hard. Then, take the white plastic locking ring and reattach to the push-to-connect adapter inside of the groove.

To check that it is sealed properly, hold the console with one hand and gently pull the tube downward to make sure it is firmly attached. The tube should not pull out from the "push-to-connect" adapter.

Make sure your push-to-connect adapter is fully tightened by screwing it counterclockwise with your fingers until it doesn't tighten anymore.

Visit [HELLOTUSHY.COM/PUSHCONNECT](https://www.hellotushy.com/pushconnect) to see a video of the installation.

#### **NEED TO DISCONNECT THE TUBE FROM THE PUSH-TO-CONNECT ADAPTER?**

No problem. First, remove the white plastic locking ring attached to the push-to-connect adapter. Push the metal collar upward to unlock the seal, and then pull the tubing out of the push-to-connect adapter.

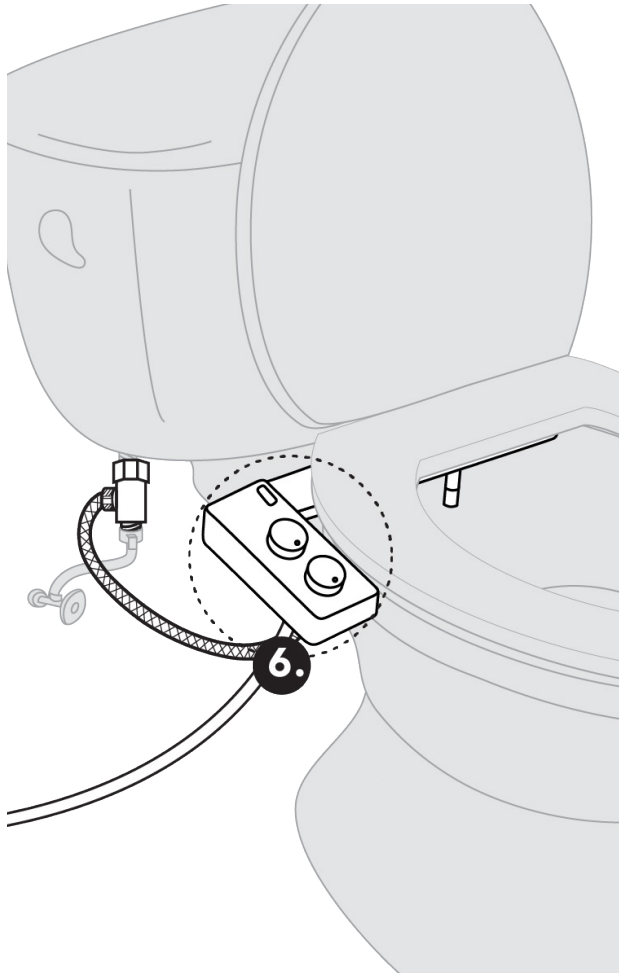

## 6. FINISH THE WATER CONNECTION



(CON'T.)

### 6b. COOL WATER CONNECTION

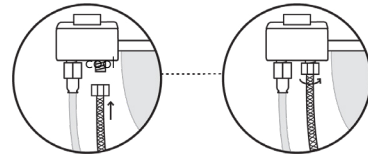

Affix the flexible steel hose from the mega adapter to the cold water port on the underside of the TUSHY console by turning counter-clockwise. Make sure your cold water threads are aligned.

### WARM WATER CONNECTION DIDN'T WORK OUT?

We'll convert your TUSHY Spa 3.0 to a TUSHY Classic 3.0. Unscrew the "push-to-connect" adapter from below the console and replace it with the inlet cap provided in the box. Voila! You can save the hot water part of the installation for another toilet, another day and still use TUSHY.

Visit [HELLOTUSHY.COM/INLETCAP](https://www.hellotushy.com/inletcap) for a how-to video.

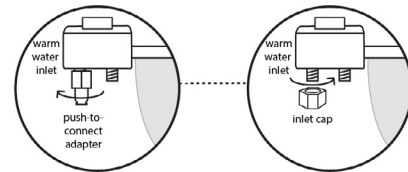

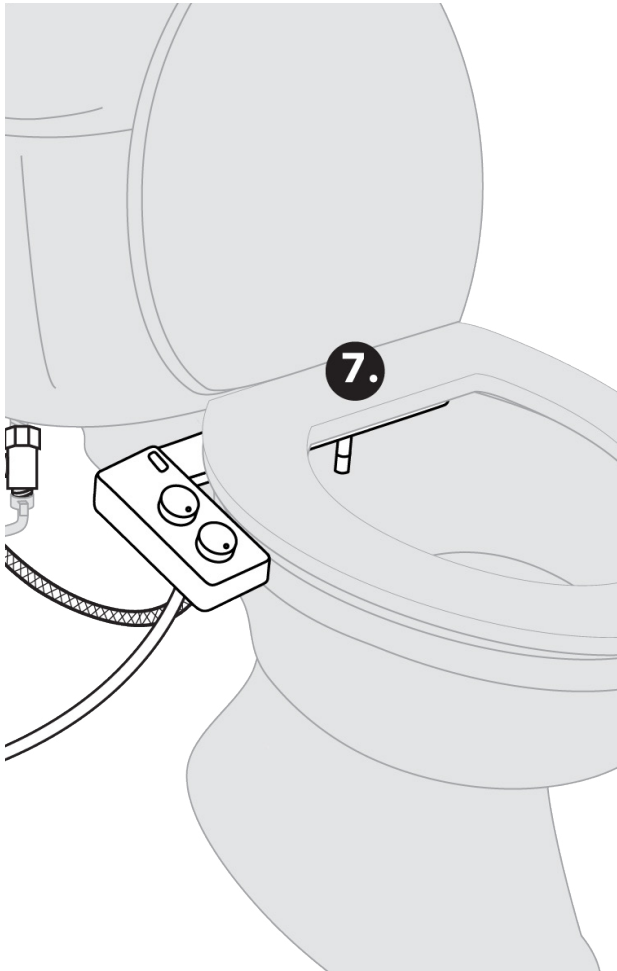

## 7. ATTACH YOUR TUSHY TO THE BOWL

---



7a.

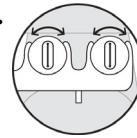

Now for the big moment ... place the TUSHY on top of your toilet and line up the adjustable flanges with the holes in between the bowl and the tank used for mounting the toilet seat.

7b.

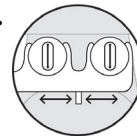

Make sure the nozzle is lined up in the center of the bowl and as close to the back rim of the bowl without the nozzle touching it. This will ensure that you have a good angle range for your nozzle.

### GIVE THE NOZZLE SOME BREATHING ROOM

Leave enough space between the rim of the toilet bowl and the bidet nozzle. Otherwise, it won't be able to adjust spray angles! You can figure out how much space you need by moving the nozzle adjuster back and forth on the nozzle adjuster on the TUSHY console.



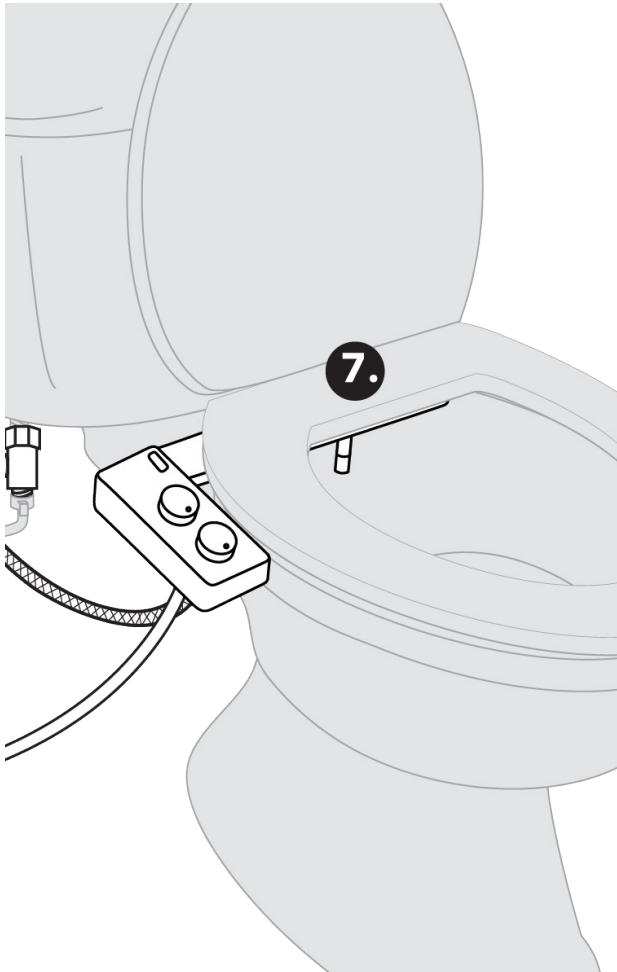

## 7. ATTACH YOUR TUSHY TO THE BOWL

---



(CON'T.)

7c.

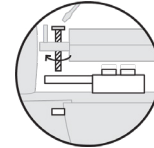

Reattach the toilet seat on top of the TUSHY by threading the toilet seat bolts through the adjustable flanges and through the toilet's mounting holes. Fasten the bolts by turning them clockwise.

**TUSHY TIP:**

Hold the underside of the toilet nuts to tighten the bolt from the top more effectively.

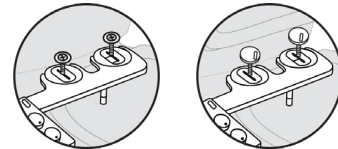

If you have a quick-release toilet seat, place those mounts you set aside on top of the TUSHY sliding seat fasteners and tighten through the toilet's mounting holes.

# 8.

## CHECK FOR LEAKS

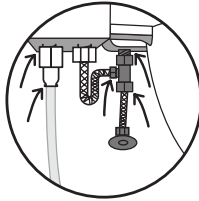

Turn each water valve on and off one at a time to check the water connections for any leaks. If you are experiencing leaks, first make sure the black rubber gasket is placed correctly inside of the push-to-connect and mega adapters. Second, make sure the threads are aligned properly. Third, make sure the hoses and adapters are tightened completely, but remember don't over-tighten!

Also be sure to touch each hose to make sure water isn't running down them. Once there is no longer leaking, make sure your water valves are open, leave a towel or a bowl below the connections and check back on it in an hour to make sure there are no slow leaks that may not be instantly visible. If there is any water present after an hour, repeat the steps above. If not, you are good to go!

If you're still having trouble, please check out the Troubleshooting section or contact us at [INSTALL@HELLOTUSHY.COM](mailto:INSTALL@HELLOTUSHY.COM).

This is a super important step so that we can avoid any leaks. Nobody wants that.

**YOUR BOOTY IS NOW  
READY FOR THE SPRAY  
OF A LIFETIME.**

# KNOW BEFORE YOU GO

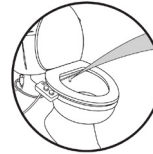

**DON'T SPRAY UNTIL YOU SIT DOWN**  
We know you'll be tempted, but unless you want a spray to the face or a soaked bathroom, don't spray until your butt is on that seat.



**TURN THE PRESSURE KNOB VERY SLOWLY**  
Adjust the pressure very slowly so that the jet isn't too strong, which may cause discomfort or injury. Ease into it and find the most comfortable pressure for you.

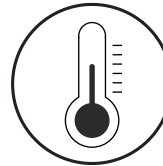

**TEMPERATURE MAY TAKE TIME TO ADJUST**  
Depending on how quickly your sink adjusts, it may take some time for your water to turn warm. If you don't want the cool water on your booty, allow the water to rinse through the nozzle wash first to get warm, and then let it rip! Remember: The water temperature will depend on your home's water temperature. Please be careful to start to test the temperature prior to use.

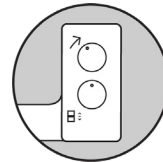

**NOZZLE WASH**  
If you get a little schmutz on the nozzle, don't freak! The nozzle is self-cleaning and will clean itself every time you turn your pressure knob to use your TUSHY.

# HOW TO USE YOUR TUSHY



## DO YOUR DOO

Don't be shy, everybody poops.

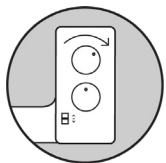

## TURN THE KNOB

Adjust the pressure from gentle butt spritz to power wash.



## FIND THE PERFECT ANGLE

Adjust the nozzle for a precise clean.

If you have any questions at all, email [INSTALL@HELLOTUSHY.COM](mailto:INSTALL@HELLOTUSHY.COM), and we will be able to ASSist you.

# FREQUENTLY ASKED QUESTIONS

## OK, BUT(T) HOW DO I DRY OFF?

If your booty is too busy to air dry, you can pat dry with our reusable, ultra-comfy TUSHY Bum Towels or our super sustainable Bamboo Toilet Paper. Using TUSHY dramatically reduces the amount of TP needed by like 80%. Endless, irritating wiping turns into just a few nice pats when you're using TUSHY!

## WHAT WILL MY FRIENDS THINK WHEN THEY SEE MY BUM TOWEL IN THE BATHROOM?

That you're a freakin' genius who not only cares for the planet, but also knows how to save money! If you lived in Europe, you'd have monogrammed bum towels for the whole family, so school your house guests about the ills of TP and show them the bidet side of life.

## I NEED AN EXTRA DOODAD TO INSTALL MY TUSHY—WHAT DO I DO?

Just like butts there is a wide variety of toilets and toilet seats. In an effort to support our sustainability goals we send you the standard parts in your TUSHY install kit that we anticipate you'll need. However, if you have any installation trouble please reach out to us directly as we have free and easy solutions for almost any issue you come across. Please contact us directly at [install@hellotushy.com](mailto:install@hellotushy.com) and we'll take care of you!

# TROUBLESHOOTING

	PROBLEM	POSSIBLE CAUSES	POSSIBLE SOLUTIONS
1	My roommates, friends, loved ones won't stop using my TUSHY.	TUSHY's awesomeness	Buy them one for their birthday.
2	There is leaking from the TUSHY body or hose connections.	<p>1. The black rubber gasket(s) are not properly installed on the hose or adapters.</p> <p>2. The mega adapter threads were cross-threaded or stripped during installation.</p> <p>3. The TUSHY or hose may need to be replaced (very rare).</p>	<p>1. Make sure that the black gasket(s) are properly installed on both ends of the console hose and the mini/mega adapter.</p> <p>2. Contact us to request of a replacement adapter.</p> <p>3. Contact us to request a replacement part or TUSHY.</p>
3	The toilet seat bolts are too short to properly affix to the toilet after installing the TUSHY.	Some toilet seats bolts are shorter than required to accommodate the TUSHY.	Install longer toilet seat bolts that will accommodate the extra ½" that the TUSHY adds to your seat setup. Please don't hesitate to contact us for potential solutions. We may be able to send you a replacement seat bolt or direct you to a replacement. Super easy fix!
4	The toilet seat bolts do not fit through the holes in the sliding seat fasteners.	Some toilet seats bolts are thicker than the required ½" to accommodate the TUSHY.	Purchase thinner toilet seat bolts. Standard toilet seat bolts will fit through the holes in the adjustable flanges.

# TROUBLESHOOTING

	PROBLEM	POSSIBLE CAUSES	POSSIBLE SOLUTIONS
5	There's no access to water next to my toilet.	<p>1. You have a flush-o-meter or commercial toilet.</p> <p>2. You have a wall-mounted toilet or a unique plumbing situation that doesn't allow you to connect at the water valve at the wall.</p>	<p>1. If you know the flushometer kit will work for you, you can purchase it on our Spare Parts page at <a href="http://hellotushy.com">hellotushy.com</a>.</p> <p>2. If you have a unique plumbing situation that you aren't sure about please reach out to our team so we can assist you!</p>
6	The ¾" mini adapter for TUSHY Spa 3.0 isn't the same size as my water connection hose.	<p>1. We bet you live in California where sometimes the connection is ½" rather than the US standard.</p> <p>2. We bet you live in Europe where sometimes the connection is a G3/8 thread instead of the US standard.</p> <p>3. We bet you have a unique plumbing setup.</p>	<p>1. Purchase the ½" Metal Adapter on our Spare Parts page at <a href="http://hellotushy.com">hellotushy.com</a>.</p> <p>2. Purchase the TUSHY G3/8 European Adapter on our Spare Parts page at <a href="http://hellotushy.com">hellotushy.com</a>.</p> <p>3. Contact our customer support at <a href="mailto:install@hellotushy.com">install@hellotushy.com</a> so we can get you set up!</p>
7	I can't disconnect my plastic tube from the push-to-connect adapter.	Your push-to-connect adapter has a locking clip.	<p>Pop the plastic locking clip off of the push-to-connect collar and then push the collar up towards the console, while pulling the tube out in the opposite direction.</p> <p>Check out <a href="http://HELLLOTUSHY.COM/PUSHCONNECT">HELLLOTUSHY.COM/PUSHCONNECT</a> for some video tips if you're having trouble.</p>

Have a problem, but the solution isn't here?  
 Email us at [INSTALL@HELLLOTUSHY.COM](mailto:INSTALL@HELLLOTUSHY.COM) and we will be able to ASSist you.

# ONE YEAR LIMITED WARRANTY

1. TUSHY warrants this product to be free from defects in materials and workmanship under conditions of normal use for a period of one (1) year from the date of purchase. This warranty is extended only to the original purchaser and is not transferable if the original purchaser sells or otherwise transfers the product. TUSHY may require proof of purchase to determine whether a claim falls within the warranty period.

2. To report any product issues and to open a claim under the warranty, contact TUSHY at [warranty@hellotushy.com](mailto:warranty@hellotushy.com). TUSHY will reach out to you to attempt to help resolve the issue.

3. If a defect covered by this warranty arises, TUSHY's obligations under this warranty are limited to repair or replacement, at TUSHY's option, provided that such products were used in accordance with the instructions. Replacement may be of the same or similar product at TUSHY's discretion and based on availability. TUSHY reserves the right to inspect the product to confirm that the issue is covered by this warranty.

4. TUSHY is not responsible for the cost of return shipping of the product.

5. This warranty does NOT apply to:

Damage or loss that occurs during shipment.

Damage, loss or injury resulting from negligent or improper use or the user's failure to follow instructions.

Damage or loss resulting from modification of the product.

Damage or loss resulting from normal "wear and tear" of the product.

Damage based on claims of personal injury or property damage, including, but not limited to, claimed damages that are incidental or consequential in nature.

6. THIS WRITTEN WARRANTY IS THE ONLY WARRANTY MADE BY TUSHY. REPAIR OR REPLACEMENT AS PROVIDED UNDER THIS WARRANTY SHALL BE THE EXCLUSIVE REMEDY AVAILABLE TO THE PURCHASER. TUSHY SHALL NOT BE RESPONSIBLE FOR LOSS OF USE OF THE PRODUCT OR FOR OTHER INCIDENTAL, SPECIAL, OR CONSEQUENTIAL DAMAGES OR EXPENSES INCURRED BY THE PURCHASER OR A THIRD PARTY, OR FOR ANY OTHER EXPENSE NOT SPECIFICALLY STATED ABOVE. EXCEPT TO THE EXTENT PROHIBITED BY APPLICABLE LAW, ANY IMPLIED WARRANTIES, INCLUDING THOSE OF MERCHANTABILITY AND FITNESS FOR A PARTICULAR PURPOSE, ARE EXPRESSLY LIMITED TO THE DURATION OF THIS WARRANTY. SOME STATES DO NOT ALLOW LIMITATIONS, SO THE ABOVE LIMITATION AND EXCLUSION MAY NOT APPLY TO YOU.

7. This warranty gives you specific legal rights, and you may also have other rights which vary from state to state.

# MEET THE TUSHY POO-RUS

## GENERAL

Say hi! Comments! Compliments! Butt Puns!  
[hello@hellotushy.com](mailto:hello@hellotushy.com)

## TUSHY QUESTIONS

Got general Qs? i.e. Shipping options, product availability  
[questions@hellotushy.com](mailto:questions@hellotushy.com)

## ORDER INQUIRIES

Track, modify, cancel or change your order or address  
[myorder@hellotushy.com](mailto:myorder@hellotushy.com)

## INSTALLATION SUPPORT

Need a hook up with the hook up? Install help, spare parts and troubleshooting  
[install@hellotushy.com](mailto:install@hellotushy.com)

## TOILET PAPER SUBSCRIPTION

Change address, change frequency, or cancel  
[tpsubscriptions@hellotushy.com](mailto:tpsubscriptions@hellotushy.com)

## RETURNS

Send it back?! OK, I guess.  
[bootyblissguarantee@hellotushy.com](mailto:bootyblissguarantee@hellotushy.com)

## V3

If you have any questions at all, email [INSTALL@HELLOTUSHY.COM](mailto:INSTALL@HELLOTUSHY.COM) and we will be able to ASSist you.

# CONGRATULATIONS

Welcome to the first bidet of the rest of your life! Your hole life is about to change, but first, let's hook this sh\*t up! This cheeky instruction booklet will walk you through, step by step, fart to fart with your installation. You'll be pooping in luxury in no time.

## ONLINE VIDEO RESOURCES

(For our visual learners)

INSTALL VIDEO:

[HELLLOTUSHY.COM/SPA3INSTALL](https://hellotushy.com/spa3install)

TIPS & HACKS:

[HELLLOTUSHY.COM/TIPS](https://hellotushy.com/tips)

YAY!  
YOU PUT  
THIS SH\*T  
TOGETHER



**TUSHY**

hellotushy.com